

MODEL 77097-4



MAXX[®]
ULTIMATE

TRAXXAS

OWNER'S MANUAL

TABLE OF CONTENTS

- 2 BEFORE YOU PROCEED
- 4 SAFETY PRECAUTIONS
- 7 TOOLS, SUPPLIES, AND REQUIRED EQUIPMENT
- 8 ANATOMY OF THE X-MAXX ULTIMATE
- 9 QUICK START: GETTING UP TO SPEED
- 10 TQi RADIO AND VELINEON POWER SYSTEM
- 18 ADJUSTING THE ELECTRONIC SPEED CONTROL
- 21 DRIVING YOUR MODEL
- 24 BASIC TUNING ADJUSTMENTS
- 26 MAINTAINING YOUR MODEL
- 28 ADVANCED TUNING ADJUSTMENTS
- 30 TQi ADVANCED TUNING GUIDE

This manual contains the instructions you will need to operate and maintain your model so that you can enjoy it for years to come. We want you to feel confident that you own one of the best-performing models in the market and that it is backed by a team of professionals who aim to provide the highest level of factory support possible. Traxxas models are about experiencing total performance and satisfaction, not just with your model, but also with the company that stands behind it.

We know you're excited about getting your new model on the road, but it's very important that you take some time to read through the Owner's Manual. This manual contains all the necessary set-up and operating procedures that will allow you to unlock the performance potential that



BEFORE YOU PROCEED

Carefully read and follow all instructions in this and any accompanying materials to prevent serious damage to your model. Failure to follow these instructions will be considered abuse and/or neglect.

Before running your model, look over this entire manual and examine the model carefully. If for some reason you decide it is not what you wanted, then do not continue any further. **Your hobby dealer absolutely cannot accept a model for return or exchange after it has been run.**

WARNINGS, HELPFUL HINTS, & CROSS-REFERENCES

Throughout this manual, you'll notice warnings and helpful hints identified by the icons below. Be sure to read them!

-  An important warning about personal safety or avoiding damage to your model and related components.
-  Special advice from Traxxas to make things easier and more fun.
-  Refers you to a page with a related topic.

REGISTERING YOUR MODEL

In order to serve you better as our customer, please register your product within 10 days of your purchase online at Traxxas.com/register.

Traxxas.com/register

Traxxas engineers designed into your model. Also be sure to read and follow the precautions and warnings in this manual and on any labels or tags attached to your model. They are there to educate you on how to operate your model safely and also get maximum life and performance from your model.

Even if you are an experienced R/C enthusiast, it's important to read and follow the procedures in this manual.

Thank you again for going with Traxxas. We work hard every day to ensure you receive the highest level of customer satisfaction possible. We truly want you to enjoy your new model!

SUPPORT

If you have any questions about your model or its operation, call the Traxxas Technical Support Line toll-free at: **1-888-TRAXXAS (1-888-872-9927)***

Technical support is available 7 days a week from 8:30am to 9:00pm central time. Technical assistance is also available at Traxxas.com/support. You may also e-mail customer support with your question at support@Traxxas.com. Join thousands of registered members in our online community at Traxxas.com.

Traxxas offers a full-service, on-site repair facility to handle any of your Traxxas service needs. Maintenance and replacement parts may be purchased directly from Traxxas by phone or online at Traxxas.com. You can save time, along with shipping and handling costs, by purchasing replacement parts from your local dealer.

Do not hesitate to contact us with any of your product support needs. We want you to be thoroughly satisfied with your new model!



Quick Start

This manual is designed with a Quick Start path that outlines the necessary procedures to get your model up and running in the shortest time possible. If you are an experienced R/C enthusiast you will find it helpful and fast. Be sure and read through the rest of the manual to learn about important safety, maintenance, and adjustment procedures. Turn to page 9 to begin.



*Toll-free support is available to U.S. residents only.

WHY IT'S THE ULTIMATE



X-Maxx® is the truck that defined Traxxas Tough™. X-Maxx Ultimate takes it to the next level with a full complement of high-strength color-matched aluminum upgrades in key performance areas. All-new belted Sledgehammer® tires transform the driving experience with more precision, greater control, and more fun behind the wheel. Carve corners like a pro thanks to X-Maxx Ultimate's ultra-smooth aluminum GTX shocks. The TQi Radio System with the Traxxas Link Wireless Module and X-Maxx Ultimate's factory-installed telemetry enable real-time data capture and set the

standard for tuning ease and versatility. To truly make this the Ultimate X-Maxx, the specs are completed with nearly every factory option available. Simply put, it's the best of the best.



Aluminum C-hubs and Steering Blocks



Precision Steering Components



Aluminum Rear Hub Carriers



2085X Metal Gear Servo



Belted Sledgehammer® Tires
on X-Maxx® Black Wheels



GTX Aluminum Shocks
with TiN shafts

FCC Compliance

This device contains a module that complies with the limits for a Class B digital device as described in part 15 of the FCC rules. Operation is subject to the following two conditions: (1) This device may not cause harmful interference, and (2) this device must accept any interference received, including interference that may cause undesired operation.

The limits for a Class B digital device are designed to provide reasonable protection against harmful interference in residential settings. This product generates, uses and can radiate radio frequency energy, and, if not operated in accordance with the instructions, may cause harmful interference to radio communications. The user is cautioned that changes or modifications not expressly approved by the party responsible for compliance could void the user's authority to operate the equipment.

Canada, Industry Canada (IC)

This Class B digital apparatus complies with Canadian ICES-003 and RSS-210. This device complies with Industry Canada license exempt RSS standard(s). Operation is subject to the following two conditions: This device may not cause interference, and This device must accept any interference, including interference that may cause undesired operation of the device.

Radio Frequency (RF) Exposure Statement

This equipment complies with radio frequency exposure limits set forth by FCC and Industry Canada for an uncontrolled environment. This equipment should be installed and operated with a minimum distance of 20 centimeters between the radiator and your body or bystanders and must not be co-located or operating in conjunction with any other antenna or transmitter.

Operation Frequency: 2414~2453 MHz

Maximum Radio Frequency Power: Maximum Peak Power 9.7 dBm

Entire contents ©2025 Traxxas. All rights reserved. Traxxas, Ready-To-Race, Ready-To-Win, X-Maxx, Velineon, and ProGraphix are trademarks or registered trademarks of Traxxas. Other brand names and marks are the property of their respective holders and are used only for purposes of identification. No part of this manual may be reproduced or distributed in print or electronic media without the express written permission of Traxxas. Specifications are subject to change without notice.

Traxxas
6250 Traxxas Way
McKinney, TX 75070
Phone: 972-549-3000
Toll-free 1-888-TRAXXAS

Internet:
Traxxas.com
E-mail:
support@Traxxas.com



All instructions and precautions outlined in this manual should be strictly followed to ensure safe operation of your model.



This model is not intended for use by children or minors under 18 years of age.



For Advanced Drivers Only. Previous experience with radio controlled models is required! These models are very large, capable of high speed and acceleration, and require the use of LiPo batteries! These models are intended for advanced users that have the experience, knowledge, and maturity to safely operate and maintain the vehicle and the LiPo battery system for the safety of themselves and others.

**WARNING! CAUTION! DANGER!**

FIRE HAZARD! This vehicle requires LiPo batteries. Charging and discharging batteries has the potential for fire, explosion, serious injury, and property damage if not performed per the instructions. In addition, Lithium Polymer (LiPo) batteries pose a SEVERE risk of fire if not properly handled per the instructions and require special care and handling procedures for long life and safe operation. LiPo batteries are intended only for advanced users that are educated on the risks associated with LiPo battery use. Traxxas does not recommend that anyone under the age of 18 use or handle LiPo battery packs without the supervision of a knowledgeable and responsible adult. Dispose of used batteries according to the instructions.

- Your model requires the use of LiPo batteries. LiPo batteries have a minimum safe discharge voltage threshold that should not be exceeded. The electronic speed control is equipped with built-in Low-Voltage Detection that alerts the driver when LiPo batteries have reached their minimum voltage (discharge) threshold. It is the driver's responsibility to stop immediately to prevent the battery pack from being discharged below its safe minimum threshold.
- Low-Voltage Detection is just one part of a comprehensive plan for safe LiPo battery use. It is critical to follow all instructions for safe and proper charging, use, and storage of LiPo batteries. Make sure you understand how to use your LiPo batteries. If you have questions about LiPo battery usage, please consult with your local hobby dealer or contact the battery manufacturer. As a reminder, all batteries should be recycled at the end of their useful life.
- ONLY use a Traxxas iD charger to charge Traxxas iD batteries. ONLY use a Lithium Polymer (LiPo) balance charger with a balance adapter port to charge LiPo batteries. Never use NiMH or NiCad-type chargers or charge modes to charge LiPo batteries. DO NOT charge LiPo batteries with a NiMH-only charger. The use of a NiMH or NiCad charger or charge mode will damage LiPo batteries and may cause fire, personal injury, and/or property damage.
- NEVER charge LiPo battery packs in series or parallel. Charging packs in series or parallel may result in improper charger cell recognition and an improper charging rate that may lead to overcharging, cell imbalance, cell damage, and fire.
- ALWAYS inspect your LiPo batteries carefully before charging. Look for any loose leads or connectors, damaged wire insulation, damaged cell packaging, impact damage, fluid leaks, swelling (a

sign of internal damage), cell deformity, missing labels, or any other damage or irregularity. If any of these conditions are observed, do not charge or use the battery pack. Follow the disposal instructions included with your battery to properly and safely dispose of the battery.

- DO NOT store or charge LiPo batteries with or around other batteries or battery packs of any type, including other LiPos.
- Store and transport your battery pack(s) in a cool dry place. DO NOT store in direct sunlight. DO NOT allow the storage temperature to exceed 140°F or 60°C, such as in the trunk of a car, or the cells may be damaged and create a fire risk.
- DO NOT disassemble LiPo batteries or cells.
- DO NOT attempt to build your own LiPo battery pack from loose cells.
- BEFORE you charge, ALWAYS confirm that the charger settings exactly match the type (chemistry), specification, and configuration of the battery to be charged. DO NOT exceed the maximum manufacturer recommended charge rate.
- DO NOT attempt to charge batteries that have an internal charge circuit or a protection circuit, batteries that have been altered from original manufacturer configuration, or batteries that have missing or unreadable labels, preventing you from properly identifying the battery type and specifications.
- ALWAYS use a Traxxas iD charger to charge Traxxas iD batteries.
- DO NOT let any exposed battery contacts or wires touch each other. This will cause the battery to short circuit and create the risk of fire.
- While charging or discharging, place the battery (all types of batteries) in a fire retardant/fire proof container and on a non-flammable surface such as concrete.
- DO NOT charge batteries inside of an automobile. DO NOT charge batteries while driving in an automobile.
- NEVER charge batteries on wood, cloth, carpet, or on any other flammable material.
- ALWAYS charge batteries in a well-ventilated area.
- REMOVE flammable items and combustible materials from the charging area.
- DO NOT leave the charger and battery unattended while charging, discharging, or anytime the charger is ON with a battery

connected. If there are any signs of a malfunction or in the event of an emergency, unplug the charger from the power source and disconnect the battery from the charger.

- DO NOT operate the charger in a cluttered space, or place objects on top of the charger or battery.
- If any battery or battery cell is damaged in any way, DO NOT charge, discharge, or use the battery.
- Keep a Class D fire extinguisher nearby in case of fire.
- DO NOT disassemble, crush, short circuit, or expose the batteries to flame or other source of ignition. Toxic materials could be released. If eye or skin contact occurs, flush with water.
- If a battery gets hot to the touch during the charging process (temperature greater than 110°F / 43°C), immediately disconnect the battery from the charger and discontinue charging.
- Allow the battery pack to cool off between runs (before charging).
- ALWAYS unplug the charger and disconnect the battery when not in use.

- ALWAYS unplug the battery from the electronic speed control when the model is not in use and when it is being stored or transported.
- DO NOT disassemble the charger.
- REMOVE the battery from your model or device before charging.
- DO NOT expose the charger to water or moisture. For indoor use only.
- DO NOT use an adapter of any kind or modify or change the battery plug/connector.
- ALWAYS store battery packs safely out of the reach of children or pets. Children should always have adult supervision when charging and handling batteries.
- Always proceed with caution and use good common sense at all times.

Terms of Use:

This product is surrendered by Traxxas to the purchaser with the understanding that the purchaser accepts the responsibility that driving this model and using the enclosed accessories in a careless, improper, or unsafe manner can result in serious injury or death. Also, the purchaser assumes all liability resulting from any misuse, unsafe handling, failure to follow instructions, or any action that constitutes a violation of any applicable laws or regulations. Traxxas, and all Traxxas suppliers and component makers, shall not be liable for personal injury, loss of property, or loss of life resulting from the use of this product under any circumstances, including intentional, reckless, negligent, or accidental behavior. Traxxas, and all Traxxas suppliers and component makers, shall also not be liable for any special, indirect, incidental, or consequential damages arising out of the assembly, installation, or use of their products or any accessory or chemical required to use their products. By the act of operating/using the product, the user accepts all resulting liability and releases Traxxas, and all Traxxas suppliers and component makers, of any and all liability associated with its use. If you as the user do not accept liability of ownership, Traxxas requests that you do not use this product. Do not open any of the enclosed materials. Return the model to your hobby dealer. **Your hobby dealer absolutely cannot accept an item for return or exchange after it has been run or is otherwise no longer in as-new condition.**

All information contained in this guide is subject to change without notice. Traxxas reserves the right to make changes and improvements to products without incurring any obligation to incorporate such improvements into products previously sold. **If you have any questions about your model or its operation, call Traxxas Customer Support at 1-888-TRAXXAS (1-888-872-9927); outside the US, +1-972-549-3000. E-mail: support@traxxas.com.**

Safety Is Your Responsibility!



WARNING: RISK OF INJURY!

Do not stand directly behind the X-Maxx Ultimate while driving to avoid personal injury from rocks, sticks, or other thrown objects, especially during full throttle starts. Keep any spectators and animals at a safe distance. Wearing eye protection is recommended.

Important Points to Remember

- Because your model is controlled by radio, it is subject to radio interference from many sources that are beyond your control. Since radio interference can cause momentary losses of radio control, always allow a safety margin in all directions around the model in order to prevent collisions.
- The motor, batteries, and speed control can become hot during use. Be careful to avoid getting burned.
- Choose the right location to drive. Your model is absolutely not intended for use on public roads or congested areas where its operation can conflict with or disrupt pedestrian or vehicular traffic. This is to prevent the possibility of injury or death resulting from collision with the model by another human being or animal.
- Do not drive the X-Maxx Ultimate by yourself. Bring a friend along to act as a spotter to alert you if a person or animal is approaching.
- Do not operate your model at night, or anytime your line of sight to the model may be obstructed or impaired in any way.
- Do not drive the model close to you where a mistake or loss of control could cause the model to collide with you or any spectator.
- Never pick up the model by its tires or wheels. Always keep your hands safely clear of moving parts whenever the batteries are plugged in.
- Always disconnect the batteries in the model when it is not in use. Never store the vehicle with batteries in the model, as this can cause a fire leading to property damage, serious personal injury or even death.
- Most importantly, use good common sense at all times.

Speed Control

Your model's electronic speed control (ESC) is an extremely powerful electronic device capable of delivering high current. Please closely follow these precautions to prevent damage to the speed control or other components.

- **Disconnect the Batteries:** Always disconnect the batteries from the speed control when not in use.
- **Insulate the Wires:** Always insulate exposed wiring with heat shrink tubing to prevent short circuits.
- **Transmitter on First:** Switch on your transmitter first before switching on the speed control to prevent runaways and erratic performance.
- **Don't Get Burned:** The ESC and motor can become extremely hot during use, so be careful not to touch them until they cool. Supply adequate airflow for cooling.
- **Use Traxxas High Current Connectors:** Do not change the battery or motor connectors. Improper wiring can cause fire or damage to the ESC. Please note that modified speed controls can be subject to a rewiring fee when returned for service.
- **No Reverse Voltage:** The ESC is not protected against reverse polarity voltage.
- Always adhere to the minimum and maximum limitations of the speed control as stated in the specifications table in the Owner's Manual. If your ESC operates on two batteries, do not mix battery types and capacities. Use the same voltage and capacity for both batteries. Using mismatched battery packs could damage the batteries and electronic speed control.

TOOLS, SUPPLIES, AND REQUIRED EQUIPMENT

Your model comes with a set of specialty metric tools. You'll need to purchase other items, available from your hobby dealer, to operate and maintain your model.

Supplied Tools and Equipment

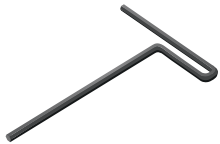

2.5mm "T"
wrench



2.5mm "L"
wrench



2.0mm "L"
wrench



17mm wheel nut
wrench

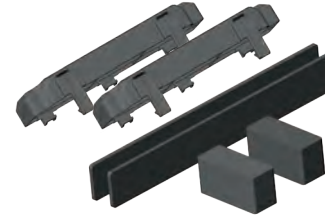

Battery pack spacers

Required Equipment



*Traxxas Power Cell LiPo Battery
(part #2890X, sold separately)*

2 LiPo batteries with Traxxas iD® High-Current Connectors

Traxxas Power Cell LiPo iD® batteries are strongly recommended for maximum performance and safer charging
Minimum: 5000mAh 11.1v 3-cell (3s)
Recommended: 6700mAh 14.8v 4-cell (4s)



LiPo battery charger

*EZ-Peak Live™
(part #2971,
sold separately)*



4 AA alkaline
batteries

*Traxxas Power Cell Batteries
(part #2914,
sold separately)*



For more information on batteries, see *Use the Right Batteries* on page 13.



Recommended Equipment

These items are not required for the operation of your model, but are a good idea to include in any R/C toolbox:

- Safety glasses
- Traxxas Ultra Premium Tire Glue, Part #6468 (CA glue)
- Hobby knife
- Side cutters and/or needle nose pliers
- Phillips screwdriver

ANATOMY OF THE X-MAXX ULTIMATE

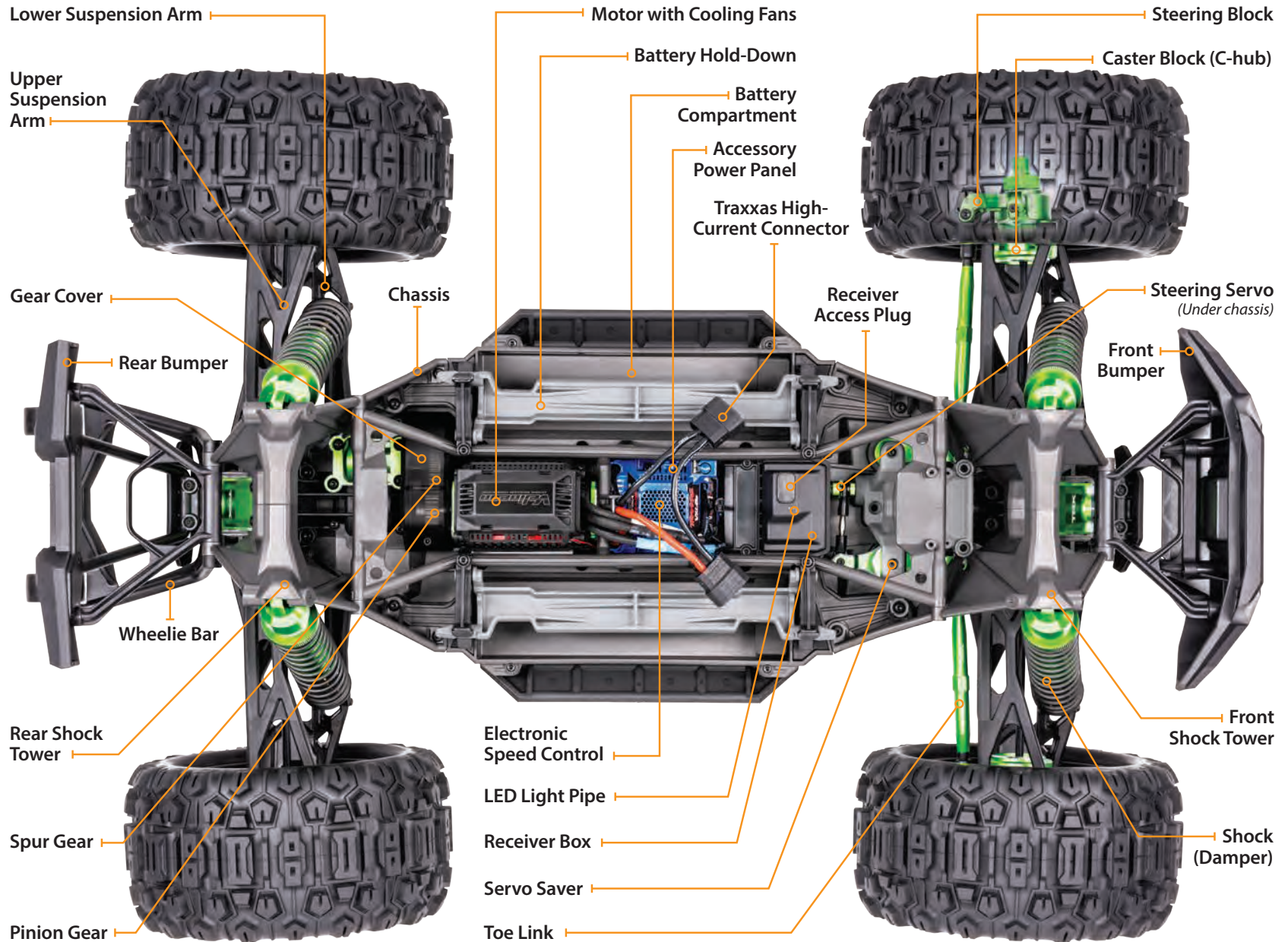

QUICK START: GETTING UP TO SPEED

 The following guide is an overview of the procedures for getting your model running. Look for the Quick Start logo on the bottom corners of Quick Start pages.

1. Read the safety precautions on page 4

For your own safety, understand where carelessness and misuse could lead to personal injury and product damage.

2. Charge two battery packs • See page 13

Your model requires two identical LiPo battery packs and a compatible battery charger (sold separately). Never use a NiMH or NiCad charger to charge LiPo battery packs.

3. Install batteries in the transmitter • See page 13

The transmitter requires 4 AA alkaline batteries (sold separately).

4. Install the battery packs in the model • See page 14

Your model requires two fully charged battery packs (sold separately).

5. Turn on the radio system • See page 15

Make a habit of turning the transmitter on first and off last.

6. Check servo operation • See page 16

Make sure the steering servo is working correctly.

7. Range test the radio system • See page 16

Follow this procedure to make sure your radio system works properly at a distance, and that there is no interference from outside sources.

8. Detail your model • See sidebar, page 10

Apply other decals if desired.

9. Drive your model • See page 21

Driving tips and adjustments for your model.

10. Maintaining your model • See page 26

Follow these critical steps to maintain the performance of your model and keep it in excellent running condition.



The Quick Start Guide is not intended to replace the full operating instructions available in this manual. Please read this entire manual for complete instructions on the proper use and maintenance of your model.

Look for the Quick Start logo at the bottom of Quick Start pages.





Applying the Decals

The main decals for your model have been applied at the factory. Additional decals are printed on self-adhesive clear mylar and are die-cut for easy removal. Use a hobby knife to lift the corner of a decal and lift it from the backing.

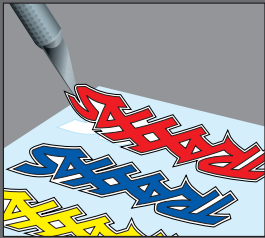

To apply the decals, place one end down, hold the other end up, and gradually smooth the decal down with your finger as you go. This will prevent air bubbles. Placing both ends of the decal down and then trying to smooth it out will result in air pockets. Look at the photos on the box for typical decal placement.

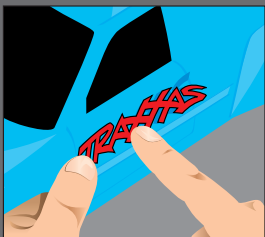

INTRODUCTION

Your model includes the latest Traxxas TQi 2.4GHz transmitter. The transmitter's easy-to-use design provides instant driving fun for new R/C enthusiasts, and also offers a full complement of pro-level tuning features for advanced users – or anyone interested in experimenting with the performance of their model. The steering and throttle channels feature adjustable Exponential, End Points, and Sub-Trims. Steering and braking Dual-Rate are also available. Many of the next-level features are controlled by the Multi-Function knob, which can be programmed to control a variety of functions. The detailed instructions (page 30) and Menu Tree (page 33) included in this manual will help you understand and operate the advanced functions of the new TQi radio system. For additional information and how-to videos, visit Traxxas.com.

RADIO AND POWER SYSTEM TERMINOLOGY

Please take a moment to familiarize yourself with these radio and power system terms. They will be used throughout this manual. A detailed explanation of the advanced terminology and features of your new radio system begins on page 30.

2.4GHz Spread Spectrum – This model is equipped with the latest R/C technology. Unlike AM and FM systems that require frequency crystals and are prone to frequency conflicts, the TQi system automatically selects and locks onto an open frequency and offers superior resistance to interference and “glitching.”

BEC (Battery Eliminator Circuit) - The BEC can either be in the receiver or in the ESC. This circuit allows the receiver and servos to be powered by the main battery pack in an electric model. This eliminates the need to carry a separate pack of 4 AA batteries to power the radio equipment.

Brushless Motor - A D/C brushless motor replaces the brushed motor's traditional commutator and brush arrangement with intelligent electronics that energize the electromagnetic windings in sequence to provide rotation. Opposite of a brushed motor, the brushless motor has its windings (coils) on the perimeter of the motor can and the magnets are mounted to the spinning rotor shaft.

Cogging - Cogging is a condition sometimes associated with brushless motors. Typically, it is a slight stutter noticed when accelerating from a stop. It happens for a very short period as the signals from the electronic speed control and the motor synch with each other. The VXL-8s electronic speed control is optimized to virtually eliminate cogging.

Current - Current is a measure of power flow through the electronics, usually measured in amps. If you think of a wire as a garden hose, current is a measure of how much water is flowing through the hose.

ESC (Electronic Speed Control) - An electronic speed control is the electronic motor control inside the model. The VXL-8s electronic speed control uses advanced circuitry to provide precise, digital proportional throttle control. Electronic speed controls use power more efficiently than mechanical speed controls so that the batteries run longer. An electronic speed control also has circuitry that prevents loss of steering and throttle control as the batteries lose their charge.

Frequency band - The radio frequency used by the transmitter to send signals to your model. This model operates on the 2.4GHz direct-sequence spread spectrum.

kV Rating - Brushless motors are often rated by their kV number. The kV rating equals no-load motor rpm with 1 volt applied. The kV increases as the number of wire turns in the motor decreases. As the kV increases, the current draw through the electronics also increases. The Velineon 1200XL motor is a 1200 kV motor.

LiPo - Abbreviation for Lithium Polymer. Rechargeable LiPo battery packs are known for their special chemistry, which allows extremely high energy density and current handling in a compact size. These are high performance batteries that require special care and handling. LiPo battery packs are for advanced users only.

mAh – Abbreviation for milliamp hour, a measure of the capacity of the battery pack. The higher the number, the longer the battery will last between recharges.

Neutral position - The standing position that the servos seek when the transmitter controls are at the neutral setting.

NiCad - Abbreviation for nickel-cadmium. The original rechargeable hobby pack, NiCad batteries have very high current handling, high capacity, and can last up to 1000 charging cycles. Good charging procedures are required to reduce the possibility of developing a “memory” effect and shortened run times.

NiMH - Abbreviation for nickel-metal hydride. Rechargeable NiMH batteries offer high current handling and much greater resistance to the “memory” effect. NiMH batteries generally allow higher capacity than NiCad batteries. They can last up to 500 charge cycles. A peak charger designed for NiMH batteries is required for optimal performance.

Receiver - The radio unit inside your model that receives signals from the transmitter and relays them to the servos.

Resistance - In an electrical sense, resistance is a measure of how an object resists or obstructs the flow of current through it. When flow is constricted, energy is converted to heat and is lost. The Velineon power system is optimized to reduce electrical resistance and the resulting power-robbing heat.

Rotor - The rotor is the main shaft of the brushless motor. In a brushless motor, the magnets are mounted to the rotor, and the electromagnetic windings are built into the motor housing.

Sensored - Sensored refers to a type of brushless motor that uses an internal sensor in the motor to communicate rotor position information back to the electronic speed control.

Sensorless - Sensorless refers to a brushless motor that uses advanced instructions from an electronic speed control to provide smooth operation. Additional motor sensors and wiring are not required. The VXL-8s electronic speed control is optimized for smooth sensorless control.

Servo - Small motor unit in your model that operates the steering mechanism.

Transmitter - The hand-held radio unit that sends throttle and steering instructions to your model.

Trim - The fine-tuning adjustment of the neutral position of the servos, made by adjusting the throttle and steering trim knobs on the face of the transmitter. **Note:** The Multi-Function knob must be programmed to serve as a throttle trim adjustment.

Thermal Shutdown Protection - Temperature sensing electronics used in the VXL-8s electronic speed control detect overloading and overheating of the transistor circuitry. If excessive temperature is detected, the unit automatically shuts down to prevent damage to the electronics.

2-channel radio system - The TQi radio system, consisting of the receiver, the transmitter, and the servos. The system uses two channels: one to operate the throttle and one to operate the steering.

Voltage - Voltage is a measure of the electrical potential difference between two points, such as between the positive battery terminal and ground. Using the analogy of the garden hose, while current is the quantity of water flow in the hose, voltage corresponds to the pressure that is forcing the water through the hose.

IMPORTANT RADIO SYSTEM PRECAUTIONS

- Do not kink the receiver’s antenna wire. Kinks in the antenna wire will reduce range.
- DO NOT CUT any part of the receiver’s antenna wire. Cutting the antenna will reduce range.
- Extend the antenna wire in the model as far as possible for maximum range. It is not necessary to extend the antenna wire out of the body, but wrapping or coiling the antenna wire should be avoided.
- Do not allow the antenna wire to extend outside the body without the protection of an antenna tube, or the antenna wire may get cut or damaged, reducing range. It is recommended to keep the wire inside the body (in the antenna tube) to prevent the chance of damage.



To prevent loss of radio range do not kink or cut the black wire, do not bend or cut the metal tip, and do not bend or cut the white wire at the end of the metal tip.

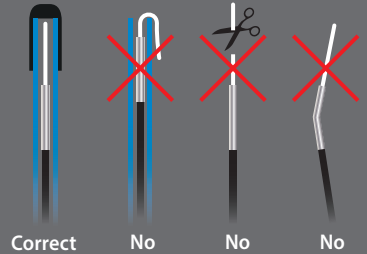

Correct

No

No

No



Velineon 1200XL Specs

Type:
Sensorless brushless

rpm/volt:
1200

Connection type:
6.5mm bullet

Diameter:
48mm (1.88")

Length:
110mm (4.32")

Weight:
665g (23.44oz)

ESC/Motor Wiring Diagram

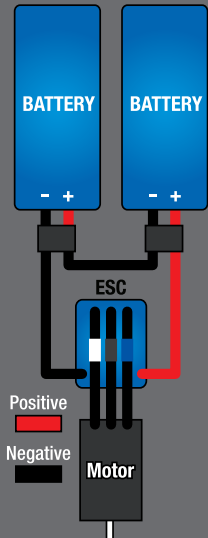

Your model is equipped with the newest TQi 2.4GHz transmitter. The transmitter has two channels for controlling your throttle and steering. The receiver inside the model has 5 output channels. Your model is equipped with one servo and an electronic speed control.

TRANSMITTER AND RECEIVER

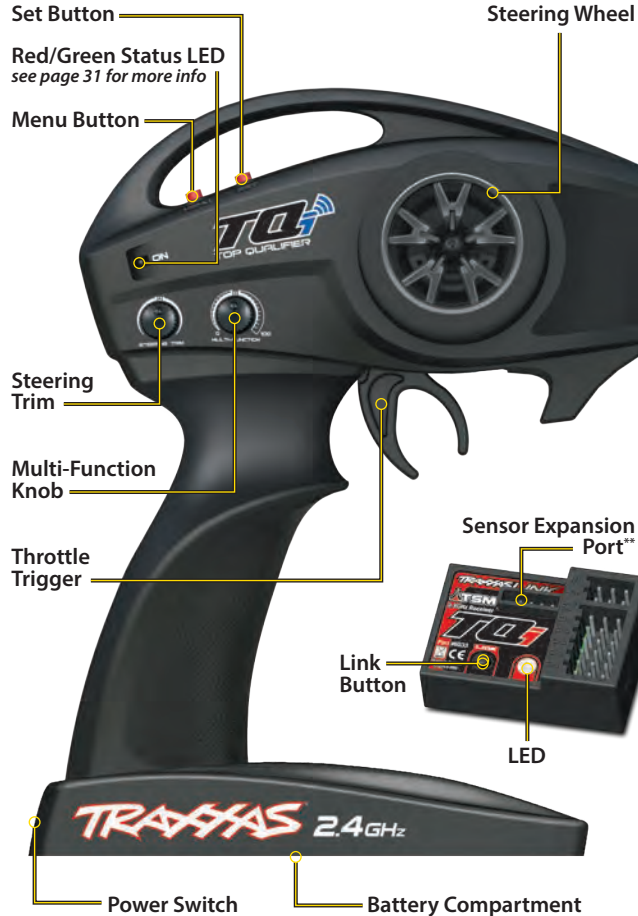

MODEL WIRING DIAGRAM

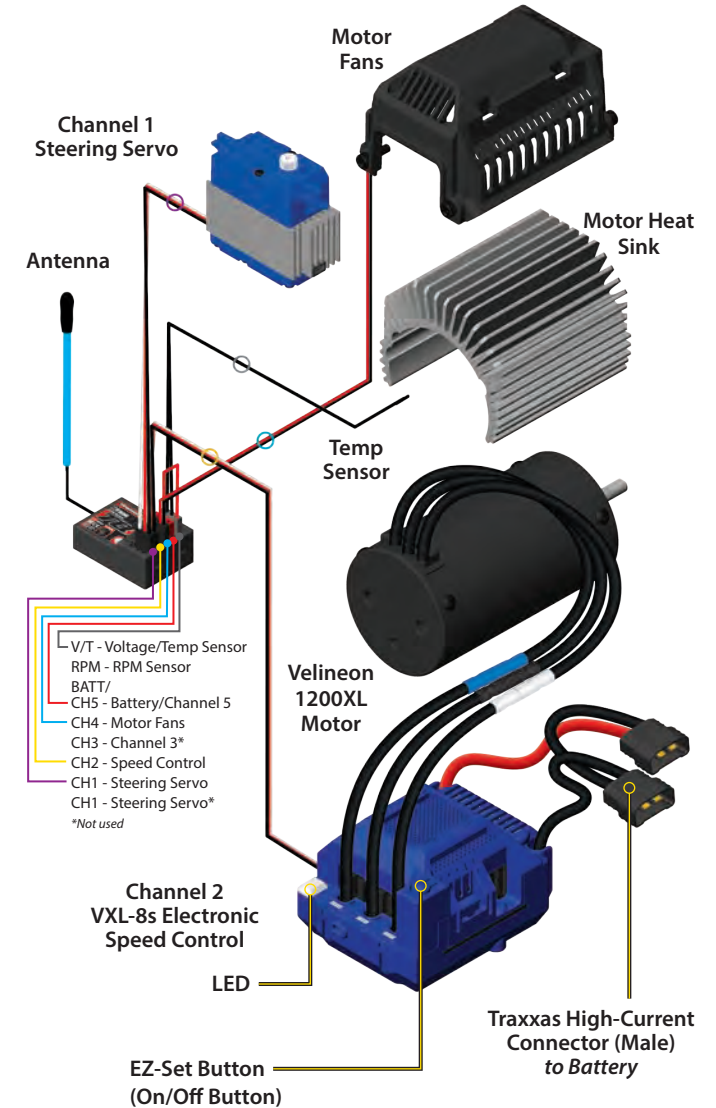

** Accessory sensor expansion port for use with the Telemetry Expander Module (see Traxxas.com and included materials for more information)

INSTALLING TRANSMITTER BATTERIES

Your TQi transmitter uses 4 AA batteries. The battery compartment is located in the base of the transmitter.



1. Remove the battery compartment door by pressing the tab and sliding the door open.
2. Install the batteries in the correct orientation, as indicated in the battery compartment.
3. Reinstall the battery compartment door and snap it closed.
4. Turn on the transmitter and check the status LED for a solid green light.

If the status LED flashes red, the transmitter batteries may be weak, discharged, or possibly installed incorrectly. Replace with new batteries. The status LED does not indicate the charge level of the battery pack installed in the model. Refer to the troubleshooting section on page 31 for more information on the transmitter status LED codes.



SELECTING BATTERIES FOR YOUR MODEL

Your model does not include batteries or a charger. Two identical LiPo batteries equipped with Traxxas iD® High Current Connectors are required. **Do not use Nickel Metal Hydride (NiMH) batteries.** Traxxas Power Cell iD batteries are strongly recommended for maximum performance and safer charging. The following chart lists available Power Cell LiPo batteries for your model:

LiPo Batteries with iD

2872X	5000mAh 11.1v 3-Cell (3s) 25C LiPo iD Battery*
2857X	6400mAh 11.1v 3-Cell (3s) 25C LiPo iD Battery*
2889X	5000mAh 14.8v 4-Cell (4s) 25C LiPo iD Battery*
2890X	6700mAh 14.8v 4-Cell (4s) 25C LiPo iD Battery

*Requires additional battery pack spacers for proper fitment.

Note: When operating the X-Maxx Ultimate with 4s LiPo and stock gearing, the top speed is 40+mph; 2s/3s LiPo performance will be much slower.



WARNING: FIRE HAZARD!

Users of Lithium Polymer (LiPo) batteries must read the Warnings and Precautions beginning on page 4. You **MUST** use a LiPo balance charger for LiPo batteries or battery damage with the potential for fire will result.

DO NOT use NiMH batteries with the VXL-8s electronic speed control. The batteries will become extremely hot and damage or injury could occur.



CAUTION

Burn hazard. Hot surface. Do not touch.

SELECTING A CHARGER FOR YOUR MODEL

Choose the correct type of charger for the batteries you select. Use Traxxas iD chargers with Traxxas iD batteries.

Charger	Part No.	LiPo Compatible	Battery iD	Max. Cells
EZ-Peak Plus, 4 amps	2970	YES	YES	3s
EZ-Peak Live, 12 amps	2971	YES	YES	4s
EZ-Peak Dual, 8 amps	2972	YES	YES	3s
EZ-Peak Live Dual, 26 amps	2973	YES	YES	4s
EZ-Peak Plus 4s, 8 amps	2981	YES	YES	4s



Use the Right Batteries

Your transmitter uses AA batteries. Use new alkaline batteries (part #2914). Do not use rechargeable AA batteries to power the TQi transmitter, as they will not provide sufficient voltage for optimum transmitter performance.

Caution: Discontinue running your model at the first sign of weak batteries (flashing red light on the transmitter) to avoid losing control.



If the status LED doesn't light green, check the polarity of the batteries. If you see any other flashing signal from the LED, refer to the chart on page 31 to identify the code.

**Battery iD**

Traxxas recommended battery packs are equipped with Traxxas Battery iD. This exclusive feature allows Traxxas battery chargers (sold separately) to automatically recognize connected battery packs and optimize the charge settings for the battery. This eliminates the need to worry over charger settings and menus for the easiest and safest charging solution possible. Visit Traxxas.com to learn more about this feature and available Traxxas iD chargers and batteries.

**Battery Compartment Specs:**

- 197mm (7.75") long
x 51.5mm (2.03") wide
- Height with stock strap:
45mm (1.77")
- Height with included
hold-down spacer:
28.5mm (1.12")

REMOVING AND INSTALLING THE BODY

Your X-Maxx Ultimate includes an innovative latching system for securing the body to the chassis. To remove the body for chassis access:

1. Turn the handle 90 degrees counterclockwise to unlock the body latch.
2. Open the latch to release the truck body from the rear shock tower.
3. Gently lift the rear of the body. Do not lift too far or the body will become difficult to remove.
4. Slide the body backward away from the front shock tower to release the front body tab. (Installation of the body is the reverse of removal.)
5. Practice this a few times until you become familiar with the latching mechanism. The more you do it, the faster you will be.

**INSTALLING THE BATTERY PACKS**

1. Pull out on the battery hold-down using the two release tabs and lift the hold-down up.
2. Insert a fully charged battery into the battery compartment with the High Current Connector positioned toward the front of the model.
3. Lower the battery hold-down and push it in toward the center of the truck to snap it closed.
4. Repeat for the opposite battery.

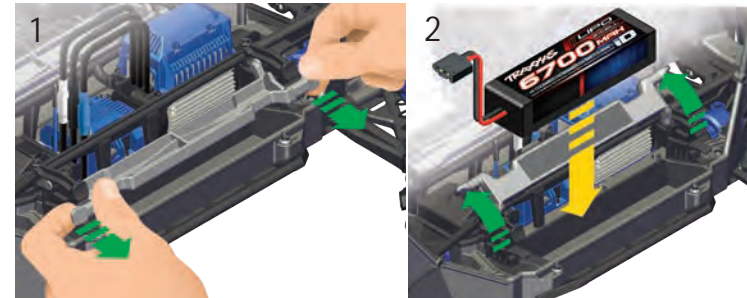

Note: The battery compartment will accommodate the Traxxas 6700mAh 4s battery pack (part #2890X). When using other LiPo batteries, additional foam blocks and battery pack spacers are required for proper fitment (see *battery chart*).

The Traxxas High-Current Connector

Your model is equipped with the Traxxas High-Current Connector. Standard connectors restrict current flow and are not capable of delivering the power needed to maximize the output of the VXL-8s. The Traxxas connector's gold-plated terminals, with large contact surfaces, ensure positive current flow with the least amount of resistance. Secure, long-lasting, and easy to grip, the Traxxas connector is engineered to extract all the power your battery has to give.



RADIO SYSTEM CONTROLS



RADIO SYSTEM RULES

- Always turn your TQi transmitter on first and off last. This procedure will help to prevent your model from receiving stray signals from another transmitter, or other source, and running out of control. Your model has electronic fail-safes to prevent this type of malfunction, but the first, best defense against a runaway model is to always turn the transmitter on first and off last.
- Always use new batteries for the radio system. Weak batteries will limit the radio signal between the receiver and the transmitter. Loss of the radio signal can cause you to lose control of your model.

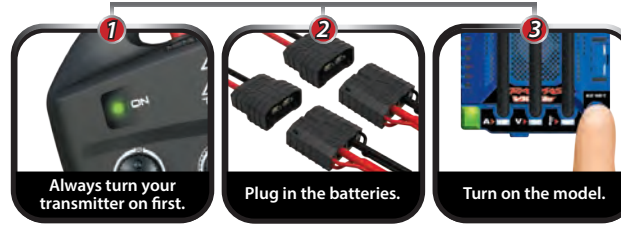

- In order for the transmitter and receiver to bind to one another, the receiver in the model must be turned on within 20 seconds of turning on the transmitter. Either the transmitter or receiver LED flashing red indicates a failure to link. If you miss it, simply turn off the transmitter and start over.
- Always turn on the transmitter before plugging in the battery.

RADIO SYSTEM BASIC ADJUSTMENTS

Steering Trim

The electronic steering trim located on the face of the transmitter adjusts the neutral (center) point of the steering channel.



Note: Traxxas Stability Management (TSM) must be completely turned off while adjusting steering trim. See page 17 for TSM adjustments.

Multi-Function Knob

The Multi-Function knob can be programmed to control a variety of functions. From the factory, the Multi-Function knob controls Traxxas Stability Management (TSM). For more detail on TSM, refer to page 17.



! Remember, always turn the TQi transmitter on first and off last to avoid damage to your model.

i **Automatic Fail-Safe**
The TQi transmitter and receiver are equipped with an automatic fail-safe system that does not require user programming. In the event of signal loss or interference, the throttle will return to neutral and the steering will hold its last commanded position. If the Fail-Safe activates while you are operating your model, determine the reason for signal loss and resolve the problem before operating your model again.

! Stop immediately at the first sign of weak batteries. Never turn the transmitter off when the battery pack is plugged in. The model could run out of control.



To turn the model off, unplug the batteries from the electronic speed control.



If the status LED doesn't light green, check the polarity of the batteries. If you see any other flashing signal from the LED, refer to the chart on page 32 to identify the code.

USING THE RADIO SYSTEM

The TQi Radio System has been pre-adjusted at the factory. The adjustment should be checked before running the model in case of movement during shipping. Here's how:

1. Turn the transmitter switch on. The status LED on the transmitter should be solid green (not flashing).
2. **Elevate the model on a block or a stand so that all the tires are off the ground.** Make sure your hands are clear of the moving parts of the model.
3. Plug the battery pack in the model into the speed control.
4. The on/off switch is integrated into the speed control. With the transmitter on, press and release the EZ-Set button (.25 seconds). The LED will shine GREEN. This turns the model on. **To turn the model off, unplug the batteries.**
5. Turn the steering wheel on the transmitter back and forth and check for rapid operation of the steering servo. Also, check that the steering mechanism is not loose or binding. If the steering operates slowly, check for weak batteries.
6. When looking down at the model, the front wheels should be pointing straight ahead. If the wheels are turned slightly to the left or right, turn off TSM (see page 17) and slowly adjust the steering trim control on the transmitter until they are pointing straight ahead; then, return the multi-function knob to the desired TSM setting.
7. Gently operate the throttle trigger to ensure that you have forward and reverse operation, and that the motor stops when the throttle trigger is at neutral. **Warning: Do not apply full throttle in forward or reverse while the model is elevated.**
8. Once adjustments are made, turn off the receiver on your model, followed by the hand-held transmitter.

Range-Testing the Radio System

Before each running session with your model, you should range-test your radio system to ensure that it operates properly.

1. Turn on the radio system and check its operation as described in the previous section.
2. Have a friend hold the model. Make sure hands and clothing are clear of the wheels and other moving parts on the model.
3. Walk away from the model with the transmitter until you reach the farthest distance you plan to operate the model.

4. Operate the controls on the transmitter once again to be sure that the model responds correctly.
5. Do not attempt to operate the model if there is any problem with the radio system or any external interference with your radio signal at your location.

Higher Speeds Require Greater Distance

The faster you drive your model, the more quickly it will near the limit of radio range. At 60mph, a model can cover 88 feet every second! It's a thrill, but use caution to keep your model in range. If you want to see your model achieve its maximum speed, it is best to position yourself in the middle of the truck's running area, not the far end, so you drive the truck towards and past your position. In addition to maximizing the radio's range, this technique will keep your model closer to you, making it easier to see and control.

No matter how fast or far you drive your model, always leave adequate space between you, the model, and others. Never drive directly toward yourself or others.

TQi Binding Instructions

For proper operation, the transmitter and receiver must be electronically "bound." **This has been done for you at the factory.** Should you ever need to re-bind the system or bind to an additional transmitter or receiver, follow these instructions. **Note:** The receiver must be connected to a 4.8-6.0v (nominal) power source for binding, and the transmitter and receiver must be within 5 feet of each other.

1. Press and hold the transmitter's SET button as you switch the transmitter on. The transmitter's LED will flash red slowly. Release the SET button.
2. Press and hold the receiver's LINK button as you switch on the speed control (by pressing the EZ-Set button). Release the LINK button.
3. When the transmitter and receiver's LEDs turn solid green, the system is bound and ready for use. Confirm that the steering and throttle operate properly before driving your model.

TRAXXAS STABILITY MANAGEMENT (TSM)



Traxxas Stability Management or TSM allows you to experience all the speed and acceleration that was engineered into your Traxxas model by helping you to maintain control of the vehicle in low-traction situations. TSM helps provide straight ahead full-throttle acceleration on slippery surfaces, without fishtailing, spinouts, or loss of control. TSM also dramatically improves braking control. High speed cornering and control is also made possible as TSM makes corrections for you, without intruding on your fun, or creating unexpected side effects.

The Multi-Function knob on the TQi transmitter has been programmed to control TSM. The recommended (default) setting for TSM is to rotate the knob to the 12:00 position (the zero mark on the dial).



Turn the knob clockwise to increase assistance; turn the knob counterclockwise to decrease assistance. Turn the knob counterclockwise to its stop to turn TSM completely off. **Note:** TSM is deactivated automatically when driving or braking in reverse.



When driving on surfaces with some traction, decrease the TSM setting to allow the vehicle to feel more "loose" for power sliding, drifting, and so on. On surfaces with very little traction (loose dirt, smooth concrete, ice/snow), increase TSM to maximize acceleration and control.

Drive with TSM on and off to test how it is making your control of the vehicle easier and more precise. For more information, visit Traxxas.com/tsm.

Note: TSM must be completely turned off while adjusting steering trim.

SETTING UP THE ANTENNA

The receiver antenna has been set up and installed from the factory. The antenna is secured by a 3x4mm set screw. To remove the antenna tube, simply remove the set screw with the included 1.5mm wrench.

When reinstalling the antenna, first slide the antenna wire into the bottom of the antenna tube until the white tip of the antenna is at the top of the tube under the black cap. Next, insert the antenna tube into the mount while making sure that antenna wire is in the slot in the antenna mount; then, install the set screw next to the antenna tube. Use the supplied 1.5mm wrench to tighten the screw just until the antenna tube is securely in place. Do not overtighten. **Do not bend or kink the antenna wire (see the sidebar for more information). Do not shorten the antenna tube.**

SELF RIGHTING

Your model is equipped with Traxxas Self Righting that will allow you to automatically return it to an upright position after a rollover. **Make sure there is adequate space around X-Maxx Ultimate and no people or animals are nearby before self righting. The model moves quickly and the tires are spinning at high speed. If a person or animal approaches the model during self righting, cancel immediately by moving the steering wheel or the throttle trigger.** Press and hold the SET button on the transmitter for four (4) seconds to activate the self-righting feature. Once activated, the SET button can be released.

Note: Certain driving surfaces or conditions may prevent the model from uprighting itself. After several attempts, self righting will cancel. Press the SET button to try again, or go and retrieve your model.



To prevent loss of radio range do not kink or cut the black wire, do not bend or cut the metal tip, and do not bend or cut the white wire at the end of the metal tip.

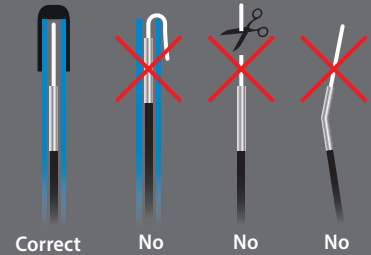

Correct

No

No

No

VXL-8s Specifications

Input voltage:
4S/6S/8S LiPo
(max. 33.6 volts)

Supported Motors:
Sensorless Brushless

Battery connector:
Traxxas High-Current
Connector

Motor connectors:
TRX 6.5mm bullet
connectors

Motor/battery wiring:
10-gauge Maxx® Cable

Weight:
182g (6.42 oz.)

Case size:
58mm (2.28")/ 72mm
(2.83")/ 46mm (1.81")

Electronic Speed Control Adjustments

The VXL-8s electronic speed control's default settings were programmed at the factory and should not require adjustment for normal operation. The following information is helpful to confirm the settings or allow you to customize the settings for your needs.

ATTENTION: USING LiPo BATTERIES

The VXL-8s electronic speed control is designed to operate on 4S, 6S, or 8S LiPo battery power. When you turn your model on, the speed control's status LED is green, indicating that **Low Voltage Detection** is activated to prevent over-discharging of LiPo batteries. **LiPo batteries are intended only for the most advanced users that are educated on the risks associated with LiPo battery use.**

DO NOT use NiMH batteries with the VXL-8s electronic speed control. The batteries will become extremely hot and damage or injury could occur.



Selecting a Throttle Mode: SPORT, RACE, or TRAINING

1. Connect two fully charged LiPo batteries to the VXL-8s and turn on your transmitter.
2. Press and hold the EZ-Set button until the LED turns solid green, then solid red and then begins blinking red. It will blink once, then twice, then three times, then repeat.
 - One blink = Sport Mode** is the default setting. It allows full forward and reverse throttle.
 - Two blinks = Race Mode** removes reverse throttle in case your track does not allow it.
 - Three blinks = Training Mode** will slow the model down by 50% to make it easier for new drivers to control the model.
3. Release the EZ-Set button after the number of blinks for the mode you wish to select. **Note:** If you missed the mode you wanted, keep the EZ-Set button pressed down and the blink cycle will repeat.
4. The LED will blink and then turn solid green. The model is ready to drive in the mode you have selected.

VXL-8s Setup Programming (calibrating the speed control and transmitter)

The speed control is calibrated at the factory. If the LED on the speed control is flashing green, then follow these steps to recalibrate it (set the throttle to the neutral position).

1. Connect two fully charged LiPo batteries to the VXL-8s.
2. Turn on the transmitter (with the throttle at neutral).
3. Press and hold the EZ-Set button (A). The LED will first turn green and then red. Release the EZ-Set button.
4. When the LED blinks RED ONCE, pull the throttle trigger to the full throttle position and hold it there (B).
5. When the LED blinks RED TWICE, push the throttle trigger to the full reverse and hold it there (C).
6. When the LED blinks GREEN ONCE, programming is complete. The LED will then shine green.

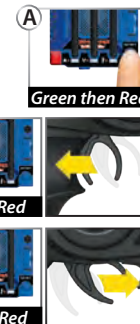

VXL-8s Profile Selection

The speed control is factory set to Profile #1 (100% forward, brakes, and reverse). To disable reverse (Profile #2) or to allow 50% forward and 50% reverse (Profile #3), follow the steps below. The speed control should be connected to the receiver and battery, and the transmitter should be adjusted as described previously. The profiles are selected by entering the programming mode.

Profile Description

Profile #1 (Sport Mode): 100% Forward, 100% Brakes, 100% Reverse
 Profile #2 (Race Mode): 100% Forward, 100% Brakes, No Reverse
 Profile #3 (Training Mode): 50% Forward, 100% Brakes, 50% Reverse

Selecting Sport Mode

(Profile #1: 100% Forward, 100% Brakes, 100% Reverse)

1. Connect two fully charged battery packs to the VXL-8s and turn on your transmitter.
2. Press and hold the EZ-Set button until the LED turns solid green, then solid red and then begins blinking red (indicating the Profile numbers).
3. When the LED blinks red once, release the EZ-Set button.
4. The LED will blink and then turn solid green. The model is ready to drive.

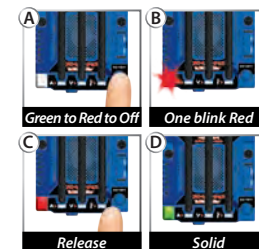

Selecting Race Mode

(Profile #2: 100% Forward, 100% Brakes, No Reverse)

1. Connect two fully charged battery packs to the VXL-8s and turn on your transmitter.
2. Press and hold the EZ-Set button until the LED turns solid green, then solid red and then begins blinking red (indicating the Profile numbers).
3. When the LED blinks red twice, release the EZ-Set button.
4. The LED will blink and then turn solid green. The model is ready to drive.

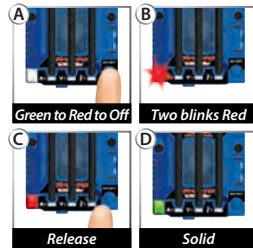

Selecting Training Mode

(Profile #3: 50% Forward, 100% Brakes, 50% Reverse)

1. Connect two fully charged battery packs to the VXL-8s and turn on your transmitter.
2. Press and hold the EZ-Set button until the LED turns solid green, then solid red and then begins blinking red (indicating the Profile numbers).
3. When the LED blinks red three times, release the EZ-Set button.
4. The LED will blink and then turn solid green. The model is ready to drive.

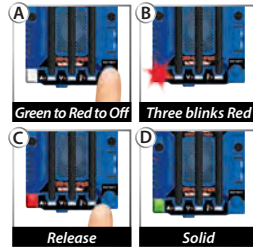

Note: If you missed the mode you wanted, keep the EZ-Set button pressed down and the blink cycle will repeat until the button is released and a mode is selected.

Accessory Power Panel

The VXL-8s electronic speed control is equipped with a power panel that can be used to power optional accessories, such as LED light kits or additional cooling fans (see Traxxas.com for additional information).

Always be sure to keep the panel cover installed when accessories are not being used to protect the pins from damage.



LED Codes and Protection Modes

The VXL-8s electronic speed control is equipped with sophisticated circuitry designed to help protect the electronics from damage caused by overloading and excessive temperatures. When a protection circuit is activated, an LED on the VXL-8s ESC will light, indicating a fault.

EZ-SET	A	V	Key	Explanation	Solution
Green	Red	Off	Off	Overcurrent Protection, Stage 1	Stop driving; inspect the vehicle for overgearing or damage.
Green	Blinking Red	Off	Off	Overcurrent Protection, Stage 2	Stop driving; inspect the vehicle for overgearing or damage.
Green	Off	Red	Off	Low Voltage Protection, Stage 1	Stop driving; inspect the batteries and recharge.
Green	Off	Blinking Red	Off	Low Voltage Protection, Stage 2	Stop driving; inspect the batteries and recharge.
Green	Off	Blinking Red	Off	Overvoltage	Stop driving and disconnect the batteries. Inspect the batteries and confirm the battery voltage.
Green	Off	Off	Red	Thermal Shutdown Protection, Stage 1	Stop driving; inspect the cooling fan on the ESC. Allow the power system to cool before continuing.
Green	Off	Off	Blinking Red	Thermal Shutdown Protection, Stage 2	Stop driving; inspect the cooling fan on the ESC. Allow the power system to cool before continuing.
Green	Red	Red	Red	Critical functioning error	Contact Traxxas Customer Service.
Blinking Red	Blinking Red	Blinking Red	Blinking Red	Programming error	Contact Traxxas Customer Service.



Patented Training Mode (Profile #3) reduces forward and reverse throttle by 50%. Training Mode is provided to reduce the power output, allowing beginning drivers to better control the model. As driving skills improve, simply change to Sport or Race Mode for full-power operation.



The VXL-8s has built-in programming that prevents accidental activation of reverse while in forward motion and vice-versa. You must come to a complete stop, release the throttle trigger, then apply opposite throttle to engage the motor in the desired direction.



- **Solid Green:** VXL-8s power-on light. Low-Voltage Detection is ACTIVATED (LiPo setting).



- **Current LED (A) Solid Red:** The VXL-8s has entered **Overcurrent Protection, Stage 1**. When excessive current flow (amperage) is being routed through the power system caused by failure to use the appropriate gearing ratio for the drivetrain and the driving surface, the VXL-8s will limit the power output to 50% throttle. Make sure your model is properly geared for the driving conditions. Before continuing, inspect the vehicle for damage. To reset, disconnect and then reconnect the batteries.



- **Current LED (A) Fast Blinking Red:** The VXL-8s has entered **Overcurrent Protection, Stage 2**. When the current flow (amperage) spikes temporarily due to a bound or restricted driveline (model is stuck against an object or encountered a restrictive driving surface), the VXL-8s will automatically shut down (fail-safe mode). Stop driving the vehicle. The VXL-8s will stay in this mode until the current flow is recovered (obstruction is removed, model is moved to a smoother driving surface) and the throttle is returned to neutral. To reset, disconnect and then reconnect the batteries.



- **Voltage LED (V) Solid Red:** The VXL-8s has entered **Low Voltage Protection, Stage 1**. When the battery voltage begins to reach the minimum recommended discharge voltage threshold for LiPo battery packs, the VXL-8s will limit the power output to 50% throttle. Stop driving the model. The VXL-8s will stay in this mode until the battery voltage is recovered or fully charged batteries are connected.



- **Voltage LED (V) Slow Blinking Red:** The VXL-8s has entered **Low Voltage Protection, Stage 2**. When the battery voltage attempts to fall below the minimum threshold, the VXL-8s will automatically shut down (fail-safe mode). The LED on the speed control will slowly blink red, indicating a low-voltage shutdown. Stop driving the model. The VXL-8s will stay in this mode until fully charged batteries are connected.



- **Voltage LED (V) Fast Blinking Red:** If the motor has no power, the VXL-8s has entered **Overvoltage Protection**. If the battery voltage from the connected battery packs is too high, the VXL-8s will go into a fail-safe mode. **WARNING:** If input voltage exceeds approximately 33.6 volts (16.8 maximum peak input voltage per battery pack), the ESC may be damaged. Do not exceed 33.6 maximum total peak voltage. Stop driving the model and disconnect the batteries.



- **Temperature LED (T) Solid Red:** The VXL-8s has entered **Thermal Shutdown Protection, Stage 1** to guard against overheating caused by excessive current flow. The VXL-8s will limit the power output to 50% throttle. Stop driving the model. Inspect the cooling fan on the ESC to make sure it is operating. Allow the power system to cool before continuing.



- **Temperature LED (T) Fast Blinking Red:** The VXL-8s has entered **Thermal Shutdown, Protection Stage 2** and has automatically shut down (fail-safe mode). Stop driving the model. Inspect the cooling fan on the ESC to make sure it is operating. Allow the power system to cool before continuing. If you are experiencing frequent warnings about temperature, it could be caused by overgearing (from stock), overly aggressive and continuous high speed driving, vehicle damage, or driving in conditions such as deep sand, heavy mud, and tall grass.



- **Current/Voltage/Temperature LEDs Solid Red or all LEDs Fast Blinking Red:** The VXL-8s has entered this protection mode due to possibly having Thermal Shutdown Protection and Low Voltage Protection (see above) occur at the same time or there is a critical functioning or programming error. Disconnect the batteries and contact Traxxas Customer Service for assistance.



Now it's time to have some fun! This section contains instructions on driving and making adjustments to your model. Before you go on, here are some important precautions to keep in mind.

Where to drive

X-Maxx Ultimate is a large vehicle capable of high speed and requires a large area to run. Choose a location where the X-Maxx Ultimate will not have an opportunity to collide with onlookers or interfere with pedestrian or vehicular traffic. Before running, also confirm that there are no local ordinances or posted signs that prevent running radio controlled vehicles (such as schools and parks). X-Maxx Ultimate is powerful and can create ruts and damage to groomed or preserved landscapes. Be considerate of others by avoiding areas where X-Maxx Ultimate could cause damage.

Mixed driving across different surface types is recommended. If you are running frequently in tall grass, deep sand, or other high load conditions, you may overheat the motor or the speed control. This will result in reduced power output until the system cools. We recommend allowing time for the power system to cool between battery packs.

- Allow the model to cool for a few minutes between runs. This is particularly important when using high-capacity battery packs that allow extended periods of running. Monitoring temperatures will extend the lives of the batteries and motors. See page 28 for advanced user information on monitoring temperatures.
- Do not continue to operate the model with low batteries or you could lose control of it. Indications of low battery power include slow operation, delayed vehicle response, or ESC shutdown due to the Low-Voltage Detection circuitry. Stop immediately at the first sign of weak batteries. When the batteries in the transmitter become weak, the power light will begin to flash red. Stop immediately and install new batteries.
- Do not drive the model at night, on public streets, or in large crowds of people.
- If the model becomes stuck against an object, do not continue to run the motor. Remove the obstruction before continuing. Do not push or pull objects with the model.
- Because the model is controlled by radio, it is subject to radio interference from many sources beyond your control. Since radio interference can cause momentary losses of control, allow a safety

margin of space in all directions around the model in order to prevent collisions.

- Use good, common sense whenever you are driving your model. Intentionally driving in an abusive and rough manner will only result in poor performance and broken parts. Take care of your model so that you can enjoy it for a long time to come.
- High-performance vehicles produce small vibrations that may loosen hardware over time. Frequently check wheel nuts and other screws on your vehicle to ensure that all hardware remains properly tightened.

About Run Time

A large factor affecting run time is the type and condition of your batteries. The milliamp hour (mAh) rating of the batteries determines how large their "fuel tank" is. A 3000mAh battery pack will theoretically run twice as long as a 1500mAh sport pack. Because of the wide variation in the types of batteries that are available and the methods with which they can be charged, it's impossible to give exact run times for the model.

Another major factor that affects run time is how the model is driven. Run times may decrease when the model is driven repetitively from a stop to top speed and with repetitive hard acceleration.

Tips for Increasing Run Time

- Use batteries with the highest mAh rating you can purchase.
- Use a high-quality peak-detecting charger.
- Read and follow all maintenance and care instructions provided by the manufacturer of your batteries and charger.
- Keep the VXL-8s cool. Get plenty of airflow across the ESC heat sinks.
- Lower your gear ratio. Installing a smaller pinion or larger spur gear will lower your gear ratio, causing less power draw from the motor and battery, and reducing overall operating temperatures.
- Maintain your model. Do not allow dirt or damaged parts to cause binding in the drivetrain. Keep the motor clean.

mAh Ratings and Power Output

The mAh rating of the battery can affect your top-speed performance. The higher capacity battery packs experience less voltage drop under heavy load than low mAh rated packs. The higher voltage potential allows increased speed until the battery begins to become discharged.



RUNNING IN WET CONDITIONS

Your new Traxxas model is designed with water-resistant features to protect the electronics in the model (receiver, servos, electronic speed control). This gives you the freedom to have fun driving your model through puddles, wet grass, snow, and through other wet conditions. Though highly water resistant, the model should not be treated as though it is submersible or totally 100% waterproof. Water resistance applies only to the installed electronic components. Running in wet conditions requires additional care and maintenance for the mechanical and electrical components to prevent corrosion of metal parts and maintain their proper function.

Precautions

- **Without proper care, some parts of your model can be seriously damaged due to contact with water. Know that additional maintenance procedures will be required after running in wet conditions in order to maintain the performance of your model. Do not run your model in wet conditions if you are not willing to accept the additional care and maintenance responsibilities.**
- **Not all batteries can be used in wet environments.** Consult your battery manufacturer to see if their batteries can be used in wet conditions.
- The Traxxas TQi transmitter is not water resistant. Do not subject it to wet conditions such as rain.
- Do not operate your model during a rain storm or other inclement weather where lightning may be present.
- Do not allow your model to come in contact with salt water (ocean water), brackish water (between fresh water and ocean water), or other contaminated water. Salt water is highly conductive and highly corrosive. Use caution if you plan to run your model on or near a beach.

Before Running Your Vehicle in Wet Conditions

1. Consult the section "After Running Your Vehicle in Wet Conditions" before proceeding. Make sure you understand the additional maintenance required with wet running.
2. The wheels have small holes molded in to allow air to enter and exit the tire during normal running. Water will enter these holes and get trapped inside the tires if holes are not cut in the tires. Cut two small holes (3mm or 1/8" diameter) in each tire. Each hole should be near the tire center-line, 180 degrees apart.
3. Confirm that the receiver box O-ring and cover are installed correctly and secure. Make sure the screws are tight and the blue

O-ring is not visibly protruding from the edge of the cover.

4. Confirm that your batteries can be used in wet conditions.
5. Use lower gearing (smaller pinion gears, as low as 11T or spur gear as large as 54T) when running in mud, deep puddles, snow, or other similar situations that will restrict the tires and put much higher loads on the motor.

Motor Precautions

- Velineon motor life can be greatly reduced in mud and water. If the motor gets excessively wet or submerged, use very light throttle (run the motor slowly) until the excess water can run out. Applying full throttle to a motor full of water can cause rapid motor failure. Your driving habits will determine motor life with a wet motor. Do not submerge the motor under water.
- Do not gear the motor by temperature when running in wet conditions. The motor will be cooled by water contact and will not give an accurate indication of appropriate gearing.
- Use special care when operating your model in muddy conditions. Stop operating your model if it appears to be straining due to the tackiness of the mud or build-up of mud on the chassis. Do not allow mud to collect on the motor or pack around the motor.

After Running Your Vehicle in Wet Conditions

1. Drain the tires by spinning the tires at high speed to "sling" the water out. One way to do this is to make several high-speed passes on a flat, dry surface (if possible).
2. Remove the batteries.
3. Rinse excess dirt and mud off the truck with low-pressure water, such as from a garden hose. Do not use a pressure washer or other high-pressure water. Avoid directing water into the bearings, differentials, etc.
4. Blow off the truck with compressed air (optional, but recommended). Wear safety glasses when using compressed air.
5. Remove the wheels from the truck.
6. Spray all the bearings, drivetrain, and fasteners with WD-40® or similar water-displacing light oil.
7. Let the truck stand or you may blow it off with compressed air. Placing the truck in a warm, sunny spot will aid drying. Trapped water and oil will continue to drip from the truck for a few hours. Place it on a towel or piece of cardboard to protect the surface underneath.

8. As a precautionary step, remove the sealed receiver box cover. While unlikely, humidity or tiny amounts of moisture or condensation may enter the receiver box during wet running. This can cause long-term problems with the sensitive electronics in the receiver. Removing the receiver box cover during storage allows the air inside to dry. This step can improve the long-term reliability of the receiver. It is not necessary to remove the receiver or unplug any of the wires.
9. **Additional Maintenance:** Increase your frequency of disassembly, inspection, and lubrication of the following items. This is necessary after extended wet use or if the vehicle will not be used for an extended period of time (such as a week or longer). This additional maintenance is needed to prevent any trapped moisture from corroding internal steel components.
 - **Stub axle housing bearings:** Remove, clean, and re-oil the bearings.
 - **Differentials:** Remove, disassemble, clean, and re-grease the differential components. Use a light coating of wheel bearing grease (from an auto parts store) on the metal gear teeth. Refer to your exploded view diagrams for help with disassembly and reassembly.

RECEIVER BOX: MAINTAINING A WATERTIGHT SEAL

Removing and Installing Radio Gear

The unique design of the receiver box allows the removal and installation of the receiver without losing the ability to maintain a watertight seal in the box. The patent-pending wire clamp feature gives you the ability to also install aftermarket radio systems and maintain the watertight features of the receiver box.

Removing the Receiver

1. To remove the cover, remove the two 3x15mm cap head screws.
2. To remove the receiver from the box, simply lift it out and set to the side. The antenna wire is still inside the clamp area and cannot be removed yet.
3. Remove the wire clamp by removing the two 3x15 cap head screws.
4. Unplug the servo cables from the receiver and remove the receiver.

Receiver Installation

1. Always install the wires into the receiver box before installing the receiver.
2. Install the antenna wire and the servo cables into the receiver box.
3. Arrange the wires neatly using the wire guides in the receiver box. The excess wire will be bundled inside the receiver box. Label which wire is for which channel.
4. Apply a small bead of silicone grease (Traxxas part #1647) to the wire clamp.
5. Install the wire clamp and tighten the two 3x15 cap head screws securely.
6. Using double-sided adhesive foam tape, install the receiver into the box.



Note: For best performance, it is recommended that the receiver be installed in the original orientation as shown.

7. Plug the wires into receiver. Refer to page 12 for the wiring diagram.
8. Make sure the box light pipe is aligned with the receiver LED. Make sure the O-ring is properly seated into the groove in the receiver box so that the cover will not pinch it or damage it in any way.
9. Install the cover and tighten the two 3x15 cap head screws securely.
10. Inspect the cover to make sure that the O-ring seal is not visible.

Traxxas has specific gearing recommendations for vehicles equipped with aluminum motor mounts. Scan the QR code below for more information and instructions.



Once you become familiar with driving your model, you might need to make adjustments for better driving performance.

Adjusting Gear Mesh

Incorrect gear mesh is the most common cause of stripped spur gears. X-Maxx makes improper gear mesh virtually impossible. A pin system helps set the motor in the proper place according to the pinion and spur gear that are selected.

To access the pin system, remove the four motor mount screws from the bottom of the chassis and lift off the motor. Next, remove the two screws that secure the gear cover and remove the gear cover. This will expose the pins. Be sure not to lose the pins that go between the motor and the chassis.

Select the desired gearing (see sidebar and scan QR code to find gearing information and pin locations). Replace the spur and pinion gears as needed. When installing the motor, install the pins into their proper locations based on the gearing that is chosen. The two pins on the bottom help to lock the motor into the proper place for correct gear mesh. Secure the motor in place with the four motor mount screws inserted from the bottom of the chassis.

Note: Should you choose to do so, you can also set the gear mesh manually without the pins. With the pins removed, use the four motor mount screws on the bottom to set gear mesh. Loosen the four screws. Cut a narrow strip of notebook paper and run it into the gear mesh. Slide the motor and pinion gear into the spur gear. Tighten the four screws, and then remove the strip of paper. You should be able to run a fresh strip of paper through the gears without binding them.



Centering Your Servo

If you have removed the servo horn from your X-Maxx's steering servo, or the servo has been removed for service or cleaning, the servo must be re-centered prior to installation of the servo horn or installation of the servo.

1. Remove the servo horn from the steering servo.
2. Connect the steering servo to channel 1 on the receiver. Connect the electronic speed control (ESC) to channel 2. The white wire on the servo lead is positioned toward the receiver's LED.
3. Turn the transmitter power switch on. Make certain the transmitter's batteries are not depleted.
4. Turn off TSM (see page 17).
5. Turn the transmitter's steering trim knob to the center "0" position.
6. Disconnect both the blue and white motor connectors (see page 12) to prevent the motor from turning during the next steps. Connect a fresh battery pack to the speed control and turn on the ESC (see page 18). The servo's output shaft will automatically jump to its center position.
7. Install the servo horn onto the servo output shaft. With the servo laying down flat, the servo horn should be installed vertically so that it is in the centered position.
8. Check servo operation by turning the steering wheel back and forth to ensure that the mechanism has been centered properly and you have equal throw in both directions. Use the transmitter's steering trim knob to fine-tune the position of the servo horn so the model tracks straight when the steering wheel is at neutral.

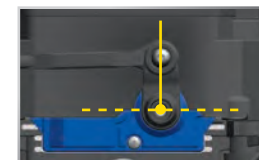

Fine Tuning the Shocks

The four GTX shocks greatly influence handling. Periodic maintenance may be required to maintain optimal performance. You can also tune your shocks to your driving style or running environment. Whenever you rebuild shocks, or make any changes to the pistons, springs, or oil, always make changes to the shocks in pairs (front or rear).

To disassemble the GTX shocks:

1. Remove the 2.5x14mm cap screw from the lower spring retainer. Remove the lower spring retainer and shock spring.
2. Remove the cartridge/shock shaft/piston assembly from the shock body.
3. Remove the M4 locknut, piston, 4x8mm washer, and the existing cartridge assembly from the shock shaft.
4. Assemble the new cartridge on the shock shaft.

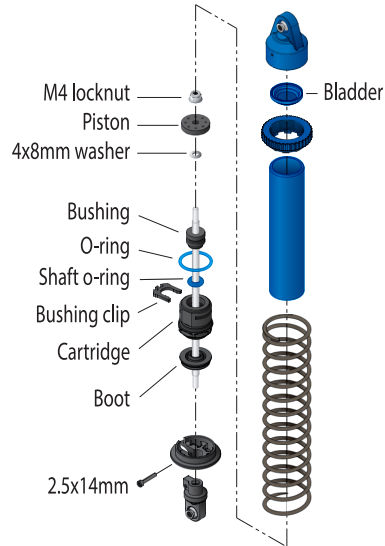

Note: The new cartridge must be assembled on the shock shaft. DO NOT attempt to assemble the cartridge separately and slide it onto the shaft. This may damage the shaft O-ring and cause a leak.

5. Reassemble in reverse order. Be sure to fill the shocks with 100% pure silicone shock oil to help prolong the life of the seals. From the factory, the GTX shocks are filled with 30W shock oil. When adding shock fluid, be sure to allow any air bubbles to escape.

You can tune your shocks by using thicker or thinner viscosity shock oil, as well as changing the piston that moves through the fluid inside the shock.

Ride height can be adjusted by using the threaded spring retainer. Adjust the ride height so that the suspension arms are just slightly above being parallel to the ground. Observe how X-Maxx Ultimate handles in turns. Proper setup will add stability and help prevent spinouts. Experiment with different shock oils and ride heights to find what works best for your driving style and conditions.

MAINTAINING YOUR MODEL



Always wear eye protection when using compressed air or spray cleaners and lubricants.



High performance vehicles generate small vibrations while driving. These vibrations may loosen hardware over time and require attention. Always check your wheel nuts and other hardware and tighten or replace when necessary.

Your model requires timely maintenance in order to stay in top running condition. **The following procedures should be taken very seriously.**

Frequently inspect the vehicle for obvious damage or wear.

Look for:

1. Cracked, bent, or damaged parts
2. Check the wheels and steering for binding.
3. Check the operation of the shock absorbers.
4. Check the wiring for any frayed wires or loose connections.
5. Check the mounting of the receiver and servo(s) and speed control.
6. Check the tightness of the wheel nuts with a wrench.
7. Check the operation of the radio system, especially the condition of the batteries.
8. Check for any loose screws in the chassis structure or suspension.
9. Check the operation of the steering servo and ensure that it is not binding.
10. Inspect the gears for wear, broken teeth, or debris lodged between the teeth.

Other periodic maintenance:

- **Cush Drive:** The cush drive system does not require maintenance, but should be inspected periodically. If the Cush Drive develops play (spur gear movement that does not also move the drive shaft), disassemble the cush drive and inspect the elastomer element (part #6465X) for damage and replace if necessary.
- **Chassis:** Be sure to keep the motor and ESC free of grass, dirt and grime to be sure to keep the components cool for optimal run times and temperatures.
- **Suspension:** Periodically inspect the model for signs of damage, such as bent or dirty suspension pins, damaged toe links, loose screws, and any signs of stress or bending. Replace components as needed.

- **Steering:** Over time, you may notice increased looseness in the steering system. The toe links may wear out from use (part #7748). Replace these components as needed to restore factory tolerances.

- **Shocks:** Keep the oil level in the shocks full. Use only 100% pure silicone shock oil to prolong the life of the seals. If you are experiencing leakage around the top of the shock, inspect the bladder in the top cap for signs of damage or distortion from overtightening. If the bottom of the shock is leaking, then it is time for a rebuild. The Traxxas rebuild kit for two shocks is part #7762.

- **Driveline:** Inspect driveshafts to make sure the drive pins are not cracked or extremely worn. Additional driveline noise can occur if the driveline components are worn out. Remove the gear cover. Inspect the spur gear for wear and check the tightness of the set screws in the pinion gears. Tighten, clean, or replace components as needed.

- **Torque-biasing center drive unit:** The X-Maxx Ultimate is equipped with a torque-biasing center drive unit. The drive unit can be rebuilt, but it requires a detailed maintenance procedure and the use of 20MM weight differential oil (part #5040). For additional information and how-to videos, please visit Traxxas.com.

Storage

When you are through running the model for the day, blow it off with compressed air or use a soft bristled paint brush to dust off the vehicle. Always disconnect and remove the battery from the model whenever the model is stored. If the model will be stored for a long time, also remove the batteries from the transmitter.

If you have questions or need technical assistance, call Traxxas at

1-888-TRAXXAS

(1-888-872-9927) (U.S. residents only)



Removing the front suspension module

1. Remove the two 3x20mm cap screws from the front of the chassis brace.
2. Remove the 3x15mm button-head cap screw from the steering link.
3. Remove the four 4x25mm button-head cap screws from the top of the chassis.
4. Remove the two 4x14mm button-head cap screws from the chassis next to the receiver box.
5. Remove the two 4x14mm button-head cap screws from the bottom of the chassis.
6. Pull the front suspension assembly away from the chassis. Pull the assembly away firmly.

To reassemble the modules, follow the steps in reverse order. There will be an audible “click” as the modules are pushed into place.

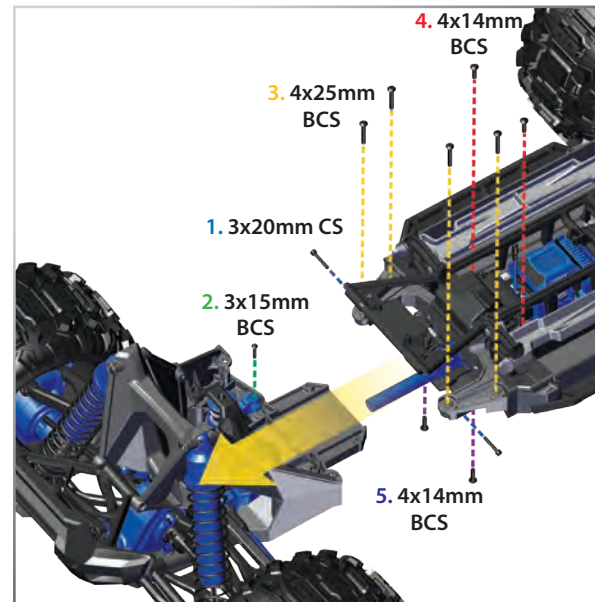

Removing the rear suspension module

1. Disconnect the three motor wires.
2. Remove the motor heat sink. Carefully remove the temperature sensor wire from the motor.
3. Remove the two 3x20mm cap screws from the chassis brace.
4. Remove the four 4x30mm cap screws from the top of the chassis.
5. Remove the four 4x14mm button-head cap screws from the middle of the chassis next to the motor.
6. Remove the two 4x14mm button-head cap screws from the bottom of the chassis.
7. Pull the rear suspension assembly away from the chassis. Pull the assembly away firmly.

To reassemble the modules, follow the steps in reverse order. There will be an audible “click” as the modules are pushed into place.

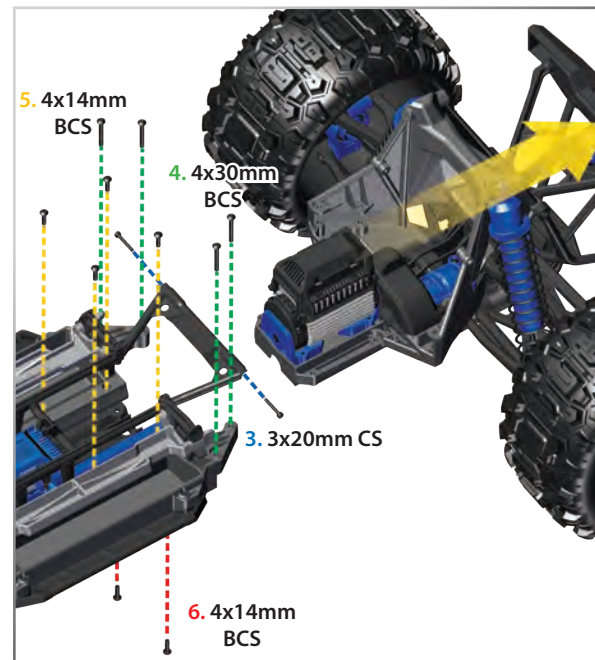



Roll Center

X-Maxx Ultimate has provisions for adjusting the roll center geometry of the front and rear suspension. Roll center refers to the virtual axis around which the chassis will roll when subjected to cornering forces. The roll center of the vehicle can be raised by mounting the inner ends of the camber links in a lower position. Raising the roll center will effectively increase the roll stiffness of the vehicle (similar to installing swaybars).

Adding roll resistance to one end of the vehicle will tend to add traction to the opposite end. For example, increasing roll resistance in the rear will provide more traction for the front wheels and potentially more steering.

Raising the roll center on the front and rear equally will increase overall roll resistance without changing the handling balance. The default factory locations are designed to make the truck easier and more forgiving to drive and less likely to traction roll in turns. X-Maxx Ultimate features two roll center positions that can be adjusted for tuning.

The upper position lowers the roll center; the bottom position raises the roll center. Out of the box, X-Maxx Ultimate is setup with the optimum roll center for handling and performance. The stock setting for the rear links is in the bottom position and the front links use the upper position.

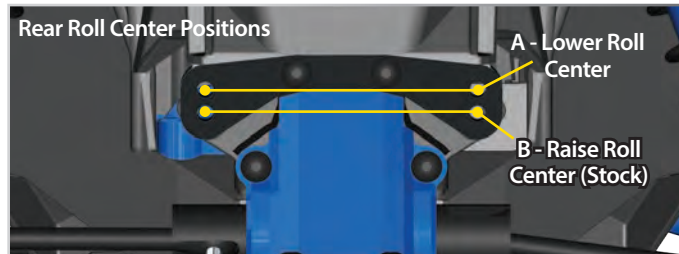
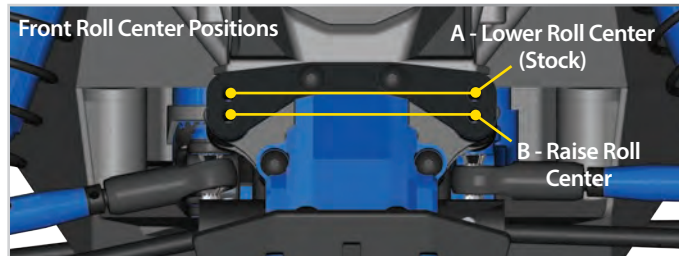

Note: If you place the front links in the bottom position (not stock), then the pivot balls in the steering will need to be flipped. The outer pivot balls come out of the box in the lower position (A). When the roll center is moved, the offset will need to be flipped (B).

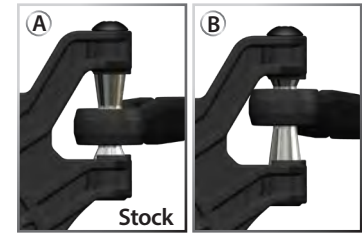

Gearing

One of the more significant advantages to your model's transmission is the wide range of available gear ratios. Changing the gearing allows you to fine tune the speed of the model and control the temperatures of the battery pack and motor. Use a lower gear ratio (numerically larger) to reduce current draw and temperatures. Use a higher gear (numerically lower) to increase top speed. Use the following formula to calculate the overall ratio for combinations not listed on the gear chart:

$$\frac{\# \text{ Spur Gear Teeth}}{\# \text{ Pinion Gear Teeth}} \times 8.11 = \text{Final Gear Ratio}$$

When using higher gear ratios, it is important to monitor the temperatures of the battery, motor, and speed control. If the battery is extremely hot (150°F) and/or the motor is too hot to touch (200°F), your model is probably over-gearing and drawing too much current. This temperature test assumes that the model is close to factory stock weight and operates freely with no excessive friction, dragging, or binding, and the battery is fully charged and in good condition. **Note:** If not using the pin system, check and adjust gear mesh if a spur and/or pinion gear is changed.

This model is equipped with a Velineon 1200XL brushless motor. The gear combination that comes stock on each model provides good overall acceleration and top speed. **If high-speed gearing is used, it is not recommended for off-road or repetitive starting and stopping.**

Temperatures and Cooling

The X-Maxx Ultimate includes several features to help cool the electronic components: a motor temperature sensor, motor cooling fans, motor heat sink, and electronic speed control cooling fan.

The motor temperature sensor is factory installed and provides accurate telemetry data and thermal overload protection for the motor. If you remove the temperature sensor for vehicle maintenance, be certain to reinstall it correctly. The sensor should be installed so the thermistor (the small component at the top of the temperature sensor) is on the top of the motor (the side where the wires exit the motor). The sensor should also be centered on the motor. If the sensor is installed incorrectly, inaccurate or false readings will be sent to the speed control, and your model's performance may be compromised. Do not operate the X-Maxx Ultimate without the temperature sensor. If the sensor is missing or incorrectly installed, overheating and permanent motor damage may occur. Damage caused by overheating is not covered by the limited warranty.

The X-Maxx Ultimate also features factory installed cooling fins. These cooling fins help pull the heat away from the motor. Also, the electronic speed control features a cooling fan to assist in cooling the VXL-8s in high current motor applications.

Tuning the Sealed Gear Differentials

The action of the front and rear gear differentials can be tuned for different driving conditions and performance requirements without major disassembly or removal of the suspension system. From the factory, the differentials are sealed to maintain consistent long-term performance. Changing the oil in the differential with either lower or higher viscosity oil will vary the performance characteristics of the differentials. Changing to higher viscosity oil in the differential will reduce the tendency for motor power to be transferred to the wheel with the least traction. You may notice this when making sharp turns on slick surfaces. The unloaded wheels on the inside of the turn have the least traction and tend to spin up to extremely high rpms. Higher viscosity (thicker) oil causes the differential to act like a limited-slip differential, distributing more equal power to the left and right wheels.

X-Maxx Ultimate will generally benefit from higher viscosity oil when climbing or racing on low traction surfaces. **Note:** Heavier oil will allow power to be transferred, even with one or more tires off the ground. This can make the vehicle more likely to overturn on high-traction surfaces.

From the factory, the front differential is filled with SAE 10,000W viscosity silicone oil. The rear differential is filled with 30,000W oil.

Only use silicone oil in the differentials. Traxxas offers SAE 10,000W, 30,000W, and 50,000W viscosity oil (see your parts list). The differentials have to be removed from the vehicle and disassembled to change/replace oil. Follow the steps below to access and refill the front and rear differentials:

Front and Rear Differential Removal:

1. Remove the two 4x20mm button-head cap screws that secure the bumper to the skid plate. Rotate the front bumper up and out of the way.
2. Remove the 4x12mm button-head cap screw (1) and the 4x16mm button-head cap screws (4) that secure the differential cover.
- Note:** To reach the screws at the bottom of the cover, slide your screwdriver through the slots in the lip of the skid plate.
3. Remove the differential cover.
4. Remove the differential from the housing. The drive axles will slide out of the differential cups. To install the differential, follow the steps in reverse order.

Refilling the Differential:

Refer to the *X-Maxx Ultimate Front Assembly in the Service and Support Guide* included with your model, or online at Traxxas.com/support for the complete differential assembly.

1. Remove the four 3x15mm cap screws to pull the differential case and ring gear apart. Work over a towel to collect any fluid that drips from the differential.
2. Drain the fluid from the differential. You may wish to remove the spider gears from the differential to make this easier.
3. Place the spider gears back into the differential case (if you removed them). Fill the differential case with fluid until the spider gears are submerged half way.
4. Rejoin the ring gear and differential case, using care to align the screw holes. Be sure the rubber gasket is in place or the differential may leak.
5. Install the four 3x15mm cap screws and tighten securely.

Front Differential Removal

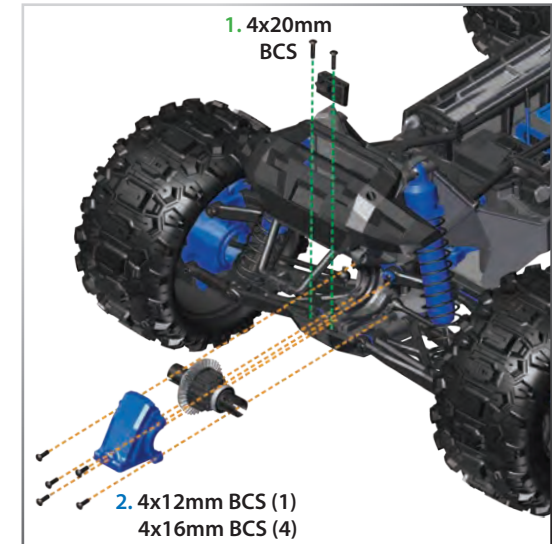

Rear Differential Removal

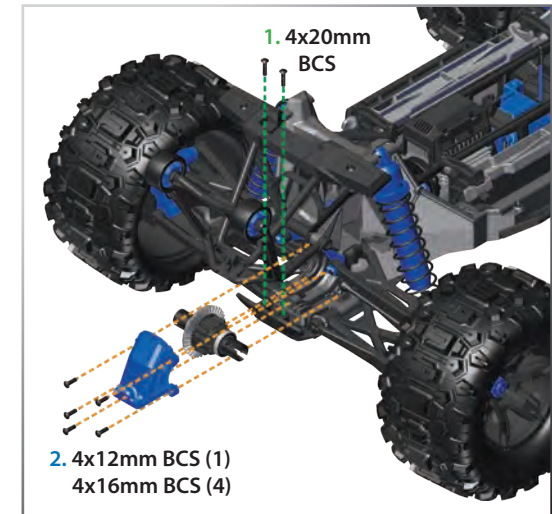

The model's TQi transmitter is equipped with the Traxxas Link Wireless Module. This innovative accessory transforms your Apple® iPhone® or iPad® or Android™ device into a powerful tuning tool that equips your TQi with an intuitive, high-definition, full-color graphical user interface.

Traxxas Link

The powerful Traxxas Link™ App (available in the Apple App Store™ or on Google Play™) gives you complete control over the operation and tuning of your Traxxas model with stunning visuals and absolute precision. With the installed Traxxas Link telemetry sensors on the model, Traxxas Link displays real-time data such as speed, RPM, temperature, and battery voltage.

Intuitive iPhone, iPad, and Android interface

Traxxas Link makes it easy to learn, understand, and access powerful tuning options. Control Drive Effects settings such as TSM assistance percentage; steering and throttle sensitivity; steering percentage; braking strength; and throttle trim by simply touching and dragging the sliders on the screen.



Tap and slide to adjust TSM, Steering Sensitivity, Throttle Trim, Braking Percent, and more!

Real-Time Telemetry

With the installed telemetry sensors, the Traxxas Link dashboard comes to life showing you speed, battery voltage, RPM, and temperature. Set threshold warnings and log maximums, minimums, or averages. Use the recording function to document your dashboard view, with sound, so that you can keep your eyes on your driving and not miss a single apex.

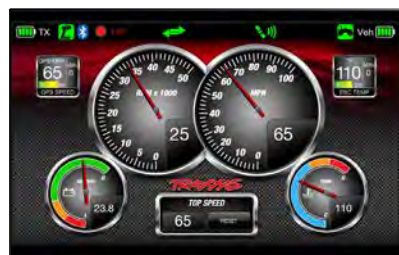

The customizable Traxxas Link dashboard delivers real-time rpm, speed, temperature, and voltage data.

Manage up to 30 Models with Traxxas Link

The TQi radio system automatically keeps track of what vehicles it has bound to and what settings were used for each—up to 30 models total! Traxxas Link provides a visual interface to name the models, customize their settings, attach profiles, and lock them into memory. Simply choose a model and any previously bound transmitter, power them up, and start having fun.

Pairing the TQi transmitter with the Traxxas Link Wireless Module and the Traxxas Link App for the first time:

1. Turn the transmitter switch on.
2. Open the Traxxas Link App on your mobile device. Touch the Garage button, and then touch the Wireless Module button (A).
3. Press the button on the Traxxas Link Wireless Module. The blue LED on the module will blink (B).

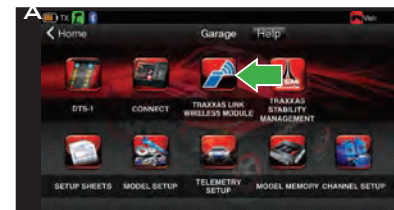

4. Within 10 seconds, touch the "Search for Traxxas Link Wireless Module" button on your mobile device (C).

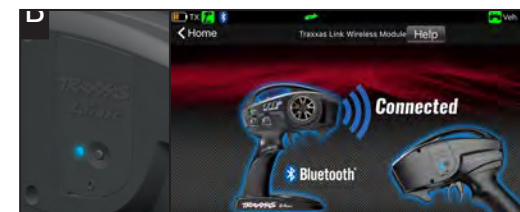

5. The Bluetooth® icon in the status bar will turn blue, and the blue LED on the module will glow solid blue (D).
6. The Traxxas Link Wireless Module and the Traxxas Link App are now paired, and will automatically connect when the transmitter is turned on and the app is running.

TRAXXAS LINK MODULE LED CODES

LED Color / Pattern	Name	Notes	
	Blue LED off	Connecting mode	Traxxas Link App is not running on a paired device.
	Slow blue (0.5 sec on / 0.5 sec off)	Pairing mode	See above for information on pairing the module with Traxxas Link App.
	Solid blue	Connected	See page 15 for information on how to use your transmitter controls.



Available Tuning Adjustments

The following items can be adjusted most easily using your mobile device and the Traxxas Link application. All the features described below may also be accessed using the MENU and SET buttons on the transmitter and observing signals from the LED. An explanation of the menu structure follows on page 37.

Your Traxxas transmitter has a programmable Multi-Function knob that can be set to control various advanced transmitter functions (set to Traxxas Stability Management by default, see page 17). Experiment with the settings and features to see if they can improve your driving experience.

Steering Sensitivity (Exponential)

The Multi-Function knob on the TQi transmitter can be set to control Steering Sensitivity (also known as exponential). The standard setting for Steering Sensitivity is “normal (zero exponential),” with the dial full left in its range of travel. This setting provides linear servo response: the steering servo’s movement will correspond exactly with the input from the transmitter’s steering

wheel. Turning the knob clockwise from center will result in “negative exponential” and decrease steering sensitivity by making the servo less responsive near neutral, with increasing sensitivity as the servo nears the limits of its travel range. The farther you turn the knob, the more pronounced the change in steering servo movement will be. The term “exponential” comes from this effect; the servo’s travel changes exponentially relative to the input from the steering wheel. The exponential effect is indicated as a percentage—the greater the percentage, the greater the effect. The illustrations below show how this works.

Normal Steering Sensitivity (0% exponential):

In this illustration, the steering servo’s travel (and with it, the steering motion of the model’s front wheels) corresponds precisely with the steering wheel. The ranges are exaggerated for illustrative purposes.

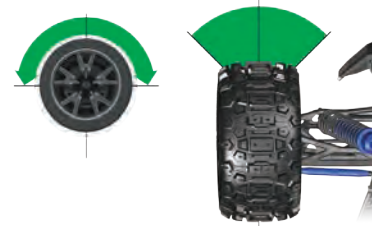

TRANSMITTER LED CODES

LED Color / Pattern	Name	Notes
● Solid green	Normal Driving Mode	See page 15 for information on how to use your transmitter controls.
⚙️ Slow red (0.5 sec on / 0.5 sec off)	Binding	See page 16 for more information on binding.
🌟 Flashing fast green (0.1 sec on / 0.15 sec off)	Throttle Trim Seek Mode	Turn the Multi-Function knob right or left until the LED stops flashing. See sidebar for more information.
🔥 Flashing medium red (0.25 sec on / 0.25 sec off)	Low Battery Alarm	Put new batteries in the transmitter. See page 13 for more information.
🔥🔥 Flashing fast red (0.125 sec on / 0.125 sec off)	Link Failure / Error	Transmitter and receiver are no longer bound. Turn the system off and then back on to resume normal operation. Find source of the link failure (i.e., out of range, low batteries, damaged antenna).
Programming Patterns		
🌟 or 🔥 Counts out number (green or red) then pauses	Current menu position	See Menu Tree for more information.
🌟 x8 Fast green 8 times	Menu setting accepted (on SET)	
🔥 x8 Fast red 8 times	Menu SET invalid	User error such as trying to delete a locked model.

RECEIVER LED CODES

LED Color / Pattern	Name	Notes
● Solid green	Normal Driving Mode	See page 15 for information on how to use your transmitter controls.
⚙️ Slow red (0.5 sec on / 0.5 sec off)	Binding	See page 16 for more information on binding.
🔥🔥 Flashing fast red (0.125 sec on / 0.125 sec off)	Fail-Safe / Low-Voltage Detect	Consistent low voltage in the receiver triggers Fail-Safe so there is enough power to center the throttle servo before it completely loses power.

📌 Throttle Trim Seek Mode

When the Multi-Function knob is set to throttle trim, the transmitter remembers the throttle trim setting. If the throttle trim knob (Multi-Function knob) is moved from the original setting while the transmitter is off, or while the transmitter was used to control another model, the transmitter ignores the actual position of the trim knob. This prevents the model from accidentally running away. The LED on the face of the transmitter will rapidly blink green and the throttle trim knob (Multi-Function knob) will not adjust the trim until it is moved back to its original position saved in memory. To restore throttle trim control, simply turn the Multi-Function knob either direction until the LED stops blinking.

📌 Fail-safe

Your Traxxas radio system is equipped with a built-in fail-safe function that returns the throttle to its last saved neutral position in the event of a signal loss. The LED on the transmitter and the receiver will rapidly flash red.

📌 Starting Over:

Restoring Factory Defaults
When programming your TQi transmitter, you may feel the need to start over with a clean slate. Follow these simple steps to restore the factory settings:

1. Turn the transmitter off.
2. Hold both MENU and SET.
3. Turn the transmitter on.
4. Release MENU and SET. The transmitter LED will blink red.
5. Press SET to clear settings. The LED will turn solid green and the transmitter is restored to default.

Decreased Steering Sensitivity (Negative Exponential):

By turning the Multi-Function knob clockwise, the steering sensitivity of the model will be decreased. Note that a relatively large amount of steering wheel travel results in a smaller amount of servo travel. The farther you turn the knob, the more pronounced the effect becomes. Decreased steering sensitivity may be helpful when driving on low-traction surfaces, when driving at high speed, or on tracks that favor sweeping turns where gentle steering inputs are required. The ranges are exaggerated for illustrative purposes.

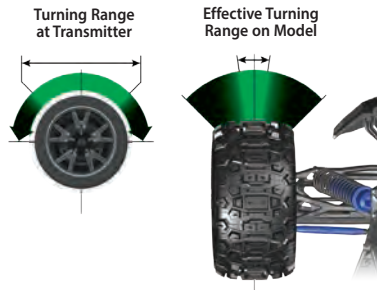

Throttle Sensitivity (Throttle Exponential)

The Multi-Function knob can be set to control Throttle Sensitivity. Throttle Sensitivity works the same way as Steering Sensitivity, but applies the effect to the throttle channel. Only forward throttle is affected; brake/reverse travel remains linear regardless of the Throttle Sensitivity setting.

Steering Percentage (Dual Rate)

The Multi-Function knob can be set to control the amount (percentage) of servo travel applied to steering. Turning the Multi-Function knob fully clockwise will deliver maximum steering throw; turning the knob counterclockwise reduces steering throw (note: turning the dial counterclockwise to its stop will eliminate all servo travel). Be aware that the steering End Point settings define the servo's maximum steering throw. If you set Steering Percentage to 100% (by turning the Multi-Function knob fully clockwise), the servo will travel all the way to its selected end point, but not past it. Many racers set Dual Rate so they have only as much steering throw as they need for the track's tightest turn, thus making the car easier to drive throughout the rest of the course. Reducing steering throw can also be useful in making a car easier to control on high-traction surfaces, and limiting steering output for oval racing where large amounts of steering travel are not required.

Steering and Throttle End Points

The TQi transmitter allows you to choose the limit of the servo's travel range (or its "end point") independently for left and right travel (on the steering channel) and throttle/brake travel (on the throttle channel). This allows you to fine-tune the servo settings to prevent binding caused by the servo moving steering or throttle linkages (in the case of a nitro car) farther than their mechanical limits. The end point adjustment settings you select will represent what you wish to be the servo's maximum travel; the Steering Percentage or Braking Percentage functions will not override the End Point settings.

Steering and Throttle Sub-Trim

The Sub-Trim function is used to precisely set the neutral point of the steering or throttle servo in the event that simply setting the trim knob to "zero" does not completely center the servo. When selected, Sub-Trim allows finer adjustment to the servo output shaft's position for precise setting of the neutral point. Always set the Steering Trim knob to zero before making final adjustment (if required) using Sub-Trim. If Throttle Trim has been previously adjusted, the Throttle Trim will need to be reprogrammed to "zero" before making final adjustment using Sub-Trim.

Braking Percentage

The Multi-Function knob may also be set to control the amount of brake travel applied by the servo in a nitro-powered model. Electric models do not have a servo-operated brake, but the Braking Percentage function still operates the same way in electric models. Turning the Multi-Function knob full clockwise will deliver maximum brake throw; turning the knob counterclockwise reduces brake throw (**Note:** Turning the dial counterclockwise to its stop will eliminate all brake action).

Throttle Trim

Setting the Multi-Function knob to serve as throttle trim will allow you to adjust the throttle's neutral position to prevent unwanted brake drag or throttle application when the transmitter trigger is at neutral. **Note:** Your transmitter is equipped with a Throttle Trim Seek mode to prevent accidental runaways. See the sidebar on page 34 for more information.

Setting Lock

Once you've adjusted all of these settings the way you like them, you may want to disable the Multi-Function knob so none of your settings can be changed. This is especially handy if you operate multiple vehicles with a single transmitter.

Multiple Settings and the Multi-Function Knob

It is important to note that settings made with the Multi-Function knob are "overlaid" on top of each other. For example, if you assign the Multi-Function knob to adjust Steering Percentage and set it for 50%, then reassign the knob to control Steering Sensitivity, the transmitter will "remember" the Steering Percentage setting. Adjustments you make to Steering Sensitivity will be applied to the 50% steering throw setting you selected previously. Likewise, setting the Multi-Function knob to "disabled" will prevent the knob from making further adjustments, but the last setting of the Multi-Function knob will still apply.

MENU TREE

The Menu Tree below shows how to navigate through the TQi transmitter's various settings and functions. Press and hold MENU to enter the Menu Tree, and use the following commands to navigate through the menu and select options.

MENU: When you enter a menu, you always start at the top. Press MENU to move down the Menu Tree. When you reach the bottom of the tree, pressing MENU again will return you to the top.

SET: Press SET to move across the Menu Tree and select options. When an option is committed to the transmitter's memory, the status LED will rapidly blink green.

BACK: Press both MENU and SET to go back one level in the Menu Tree.

EXIT: Press and hold MENU to exit programming. Your selected options will be saved.

ECHO: Press and hold SET to activate the "echo" function. Echo will "play back" your current position on the Menu Tree should you lose your place. For example: If your current position is Steering Channel End Points, holding SET will cause the LED to blink green twice, green once, and then red three times. Echo will not alter your adjustments or change your position in the programming sequence.

Below is an example of how to access a function in the Menu Tree. In the example, the user is setting the Multi-Function knob to be a Steering % (Dual-Rate) control.

- To set the Multi-Function knob to control STEERING % (DUAL-RATE):
1. Switch the transmitter on.
 2. Press and hold MENU until the green LED lights. It will blink in single intervals.
 3. Press SET. The red LED will blink in single intervals to indicate Steering Sensitivity (Expo) has been selected.
 4. Press MENU twice. The red LED will blink three times repeatedly to indicate Steering % (Dual-Rate) has been selected.
 5. Press SET to select. The green LED will blink 8 times fast to indicate successful selection.
 6. Press and hold MENU to return to driving mode.

Restoring Factory Defaults:

Transmitter OFF	Hold both MENU and SET	Transmitter ON	Release MENU and SET red LED blinks	Press SET to clear settings. LED will turn solid green. Transmitter is restored to default
-----------------	------------------------	----------------	-------------------------------------	--

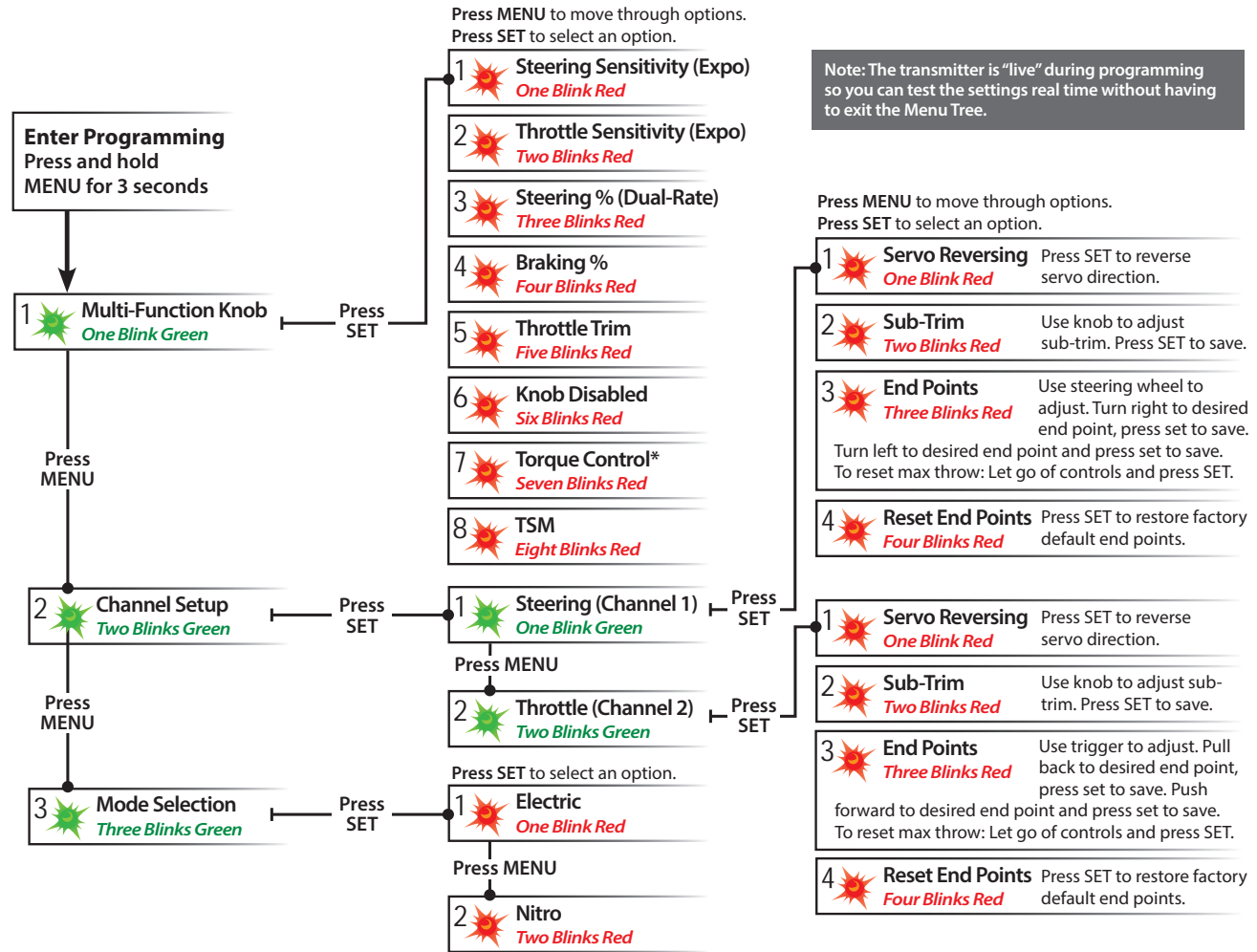

*Torque Control is a feature designed only for use with the power system in the Traxxas Funny Car Race Replica (Model #6907).

Set Multi-Function knob for STEERING SENSITIVITY (Expo)	Press/hold MENU green LED blinks	Press SET red LED blinks	Press SET x8 green LED blinks (x8)	Press/hold MENU returns to driving mode						
Set Multi-Function knob for THROTTLE SENSITIVITY (Expo)	Press/hold MENU green LED blinks	Press SET red LED blinks	Press MENU to confirm red LED blinks (x2)	Press SET to select green LED blinks (x8)	Press/hold MENU returns to driving mode					
Set Multi-Function knob for STEERING DUAL RATE (%)	Press/hold MENU green LED blinks	Press SET red LED blinks	Press MENU twice red LED blinks (x3)	Press SET to select green LED blinks (x8)	Press/hold MENU returns to driving mode					
Set Multi-Function knob for BRAKING PERCENTAGE (%)	Press/hold MENU green LED blinks	Press SET red LED blinks	Press MENU 3 times red LED blinks (x4)	Press SET to select green LED blinks (x8)	Press/hold MENU returns to driving mode					
Set Multi-Function knob for THROTTLE TRIM	Press/hold MENU green LED blinks	Press SET red LED blinks	Press MENU 4 times red LED blinks (x5)	Press SET to select green LED blinks (x8)	Press/hold MENU returns to driving mode	Adjust the Multi-Function knob until the LED turns solid green.				
To LOCK the Multi-Function knob	Press/hold MENU green LED blinks	Press SET red LED blinks	Press MENU 5 times red LED blinks (x6)	Press SET to lock green LED blinks (x8)	Press/hold MENU returns to driving mode					
To REVERSE the direction of STEERING servo	Press/hold MENU green LED blinks	Press MENU x2 green LED blinks (x2)	Press SET green LED blinks	Press SET red LED blinks	Press SET to reverse servo direction	Press/hold MENU returns to driving mode				
To set the SUB TRIM of the STEERING servo	Press/hold MENU green LED blinks	Press MENU x2 green LED blinks (x2)	Press SET green LED blinks	Press SET red LED blinks	Press MENU x2 red LED blinks (x2)	Use Multi-Function knob to set neutral	Press SET x8 to save position	Press/hold MENU returns to driving mode		
To set the END POINTS of the STEERING servo	Press/hold MENU green LED blinks	Press MENU x2 green LED blinks (x2)	Press SET green LED blinks	Press SET red LED blinks	Press MENU twice red LED blinks (x3)	Turn steering wheel to desired max left and right travel	Press SET x8 to save each position	Turn steering wheel to test settings	Press/hold MENU returns to driving mode	IF END POINTS ARE OK: Press SET and repeat steps 6-8
To reset the END POINTS of STEERING servo to defaults	Press/hold MENU green LED blinks	Press MENU x2 green LED blinks (x2)	Press SET green LED blinks	Press SET red LED blinks	Press MENU x4 red LED blinks (x4)	Press SET x8 to reset end points	Press/hold MENU returns to driving mode			
To REVERSE the direction of THROTTLE servo	Press/hold MENU green LED blinks	Press MENU x2 green LED blinks (x2)	Press SET green LED blinks	Press MENU x2 green LED blinks (x2)	Press SET red LED blinks	Press SET x8 to reverse servo direction	Press/hold MENU returns to driving mode			
To set the SUB TRIM of the THROTTLE servo	Press/hold MENU green LED blinks	Press MENU x2 green LED blinks (x2)	Press SET green LED blinks	Press MENU x2 green LED blinks (x2)	Press SET red LED blinks	Press MENU x2 red LED blinks (x2)	Use Multi-Function knob to set neutral	Press SET x8 to save position	Press/hold MENU returns to driving mode	
To set the END POINTS of the THROTTLE servo	Press/hold MENU green LED blinks	Press MENU x2 green LED blinks (x2)	Press SET green LED blinks	Press MENU x2 green LED blinks (x2)	Press SET red LED blinks	Press MENU twice red LED blinks (x3)	Use throttle trigger to set desired max throttle or brake	Press SET to save Use trigger to test	Press/hold MENU returns to driving mode	IF END POINTS ARE OK: Press SET and repeat steps 7-9
To reset the END POINTS of THROTTLE servo to defaults	Press/hold MENU green LED blinks	Press MENU x2 green LED blinks (x2)	Press SET green LED blinks	Press MENU x2 green LED blinks (x2)	Press SET red LED blinks	Press MENU x4 red LED blinks (x4)	Press SET x8 green LED blinks (x8)	Press/hold MENU returns to driving mode		

MENU TREE FORMULAS

To select functions and make adjustments to the TQi transmitter without referencing the menu tree, turn your transmitter on, find the function in the left column you wish to adjust, and simply follow the corresponding steps.



Always turn your transmitter on first.



MAXX[®]
ULTIMATE

OWNER'S MANUAL

TRAXXAS

6250 TRAXXAS WAY, MCKINNEY, TEXAS 75070

1-888-TRAXXAS